

**NFPA<sup>®</sup>**

**12**

---

**Standard on  
Carbon Dioxide  
Extinguishing Systems**

---

**2018**



## IMPORTANT NOTICES AND DISCLAIMERS CONCERNING NFPA® STANDARDS

### NOTICE AND DISCLAIMER OF LIABILITY CONCERNING THE USE OF NFPA STANDARDS

NFPA® codes, standards, recommended practices, and guides (“NFPA Standards”), of which the document contained herein is one, are developed through a consensus standards development process approved by the American National Standards Institute. This process brings together volunteers representing varied viewpoints and interests to achieve consensus on fire and other safety issues. While the NFPA administers the process and establishes rules to promote fairness in the development of consensus, it does not independently test, evaluate, or verify the accuracy of any information or the soundness of any judgments contained in NFPA Standards.

The NFPA disclaims liability for any personal injury, property, or other damages of any nature whatsoever, whether special, indirect, consequential or compensatory, directly or indirectly resulting from the publication, use of, or reliance on NFPA Standards. The NFPA also makes no guaranty or warranty as to the accuracy or completeness of any information published herein.

In issuing and making NFPA Standards available, the NFPA is not undertaking to render professional or other services for or on behalf of any person or entity. Nor is the NFPA undertaking to perform any duty owed by any person or entity to someone else. Anyone using this document should rely on his or her own independent judgment or, as appropriate, seek the advice of a competent professional in determining the exercise of reasonable care in any given circumstances.

The NFPA has no power, nor does it undertake, to police or enforce compliance with the contents of NFPA Standards. Nor does the NFPA list, certify, test, or inspect products, designs, or installations for compliance with this document. Any certification or other statement of compliance with the requirements of this document shall not be attributable to the NFPA and is solely the responsibility of the certifier or maker of the statement.

### REVISION SYMBOLS IDENTIFYING CHANGES FROM THE PREVIOUS EDITION

Text revisions are shaded. A **Δ** before a section number indicates that words within that section were deleted and a **Δ** to the left of a table or figure number indicates a revision to an existing table or figure. When a chapter was heavily revised, the entire chapter is marked throughout with the **Δ** symbol. Where one or more sections were deleted, a **•** is placed between the remaining sections. Chapters, annexes, sections, figures, and tables that are new are indicated with an **N**.

Note that these indicators are a guide. Rearrangement of sections may not be captured in the markup, but users can view complete revision details in the First and Second Draft Reports located in the archived revision information section of each code at [www.nfpa.org/docinfo](http://www.nfpa.org/docinfo). Any subsequent changes from the NFPA Technical Meeting, Tentative Interim Amendments, and Errata are also located there.

### REMINDER: UPDATING OF NFPA STANDARDS

Users of NFPA codes, standards, recommended practices, and guides (“NFPA Standards”) should be aware that NFPA Standards may be amended from time to time through the issuance of a Tentative Interim Amendment (TIA) or corrected by Errata. An official NFPA Standard at any point in time consists of the current edition of the document together with any TIAs and Errata then in effect.

To determine whether an NFPA Standard has been amended through the issuance of Tentative Interim Amendments or corrected by Errata, go to [www.nfpa.org/docinfo](http://www.nfpa.org/docinfo) to choose from the list of NFPA Standards or use the search feature to select the NFPA Standard number (e.g., NFPA 13). The document information page provides up-to-date document-specific information as well as postings of all existing TIAs and Errata. It also includes the option to register for an “Alert” feature to receive an automatic email notification when new updates and other information are posted regarding the document.

# IMPORTANT NOTICES AND DISCLAIMERS CONCERNING NFPA® STANDARDS

## ADDITIONAL NOTICES AND DISCLAIMERS

### Updating of NFPA Standards

Users of NFPA codes, standards, recommended practices, and guides (“NFPA Standards”) should be aware that these documents may be superseded at any time by the issuance of new editions or may be amended from time to time through the issuance of Tentative Interim Amendments or corrected by Errata. An official NFPA Standard at any point in time consists of the current edition of the document together with any Tentative Interim Amendments and any Errata then in effect. In order to determine whether a given document is the current edition and whether it has been amended through the issuance of Tentative Interim Amendments or corrected through the issuance of Errata, consult appropriate NFPA publications such as the National Fire Codes® Subscription Service, visit the NFPA website at [www.nfpa.org](http://www.nfpa.org), or contact the NFPA at the address listed below.

### Interpretations of NFPA Standards

A statement, written or oral, that is not processed in accordance with Section 6 of the Regulations Governing the Development of NFPA Standards shall not be considered the official position of NFPA or any of its Committees and shall not be considered to be, nor be relied upon as, a Formal Interpretation.

### Patents

The NFPA does not take any position with respect to the validity of any patent rights referenced in, related to, or asserted in connection with an NFPA Standard. The users of NFPA Standards bear the sole responsibility for determining the validity of any such patent rights, as well as the risk of infringement of such rights, and the NFPA disclaims liability for the infringement of any patent resulting from the use of or reliance on NFPA Standards.

NFPA adheres to the policy of the American National Standards Institute (ANSI) regarding the inclusion of patents in American National Standards (“the ANSI Patent Policy”), and hereby gives the following notice pursuant to that policy:

NOTICE: The user’s attention is called to the possibility that compliance with an NFPA Standard may require use of an invention covered by patent rights. NFPA takes no position as to the validity of any such patent rights or as to whether such patent rights constitute or include essential patent claims under the ANSI Patent Policy. If, in connection with the ANSI Patent Policy, a patent holder has filed a statement of willingness to grant licenses under these rights on reasonable and nondiscriminatory terms and conditions to applicants desiring to obtain such a license, copies of such filed statements can be obtained, on request, from NFPA. For further information, contact the NFPA at the address listed below.

### Law and Regulations

Users of NFPA Standards should consult applicable federal, state, and local laws and regulations. NFPA does not, by the publication of its codes, standards, recommended practices, and guides, intend to urge action that is not in compliance with applicable laws, and these documents may not be construed as doing so.

### Copyrights

NFPA Standards are copyrighted. They are made available for a wide variety of both public and private uses. These include both use, by reference, in laws and regulations, and use in private self-regulation, standardization, and the promotion of safe practices and methods. By making these documents available for use and adoption by public authorities and private users, the NFPA does not waive any rights in copyright to these documents.

Use of NFPA Standards for regulatory purposes should be accomplished through adoption by reference. The term “adoption by reference” means the citing of title, edition, and publishing information only. Any deletions, additions, and changes desired by the adopting authority should be noted separately in the adopting instrument. In order to assist NFPA in following the uses made of its documents, adopting authorities are requested to notify the NFPA (Attention: Secretary, Standards Council) in writing of such use. For technical assistance and questions concerning adoption of NFPA Standards, contact NFPA at the address below.

### For Further Information

All questions or other communications relating to NFPA Standards and all requests for information on NFPA procedures governing its codes and standards development process, including information on the procedures for requesting Formal Interpretations, for proposing Tentative Interim Amendments, and for proposing revisions to NFPA standards during regular revision cycles, should be sent to NFPA headquarters, addressed to the attention of the Secretary, Standards Council, NFPA, 1 Batterymarch Park, P.O. Box 9101, Quincy, MA 02269-9101; email: [stds\\_admin@nfpa.org](mailto:stds_admin@nfpa.org).

For more information about NFPA, visit the NFPA website at [www.nfpa.org](http://www.nfpa.org). All NFPA codes and standards can be viewed at no cost at [www.nfpa.org/docinfo](http://www.nfpa.org/docinfo).

Copyright © 2017 National Fire Protection Association®. All Rights Reserved.

## NFPA® 12

### Standard on

## Carbon Dioxide Extinguishing Systems

### 2018 Edition

This edition of NFPA 12, *Standard on Carbon Dioxide Extinguishing Systems*, was prepared by the Technical Committee on Gaseous Fire Extinguishing Systems. It was issued by the Standards Council on November 10, 2017, with an effective date of November 30, 2017, and supersedes all previous editions.

This edition of NFPA 12 was approved as an American National Standard on November 30, 2017.

### Origin and Development of NFPA 12

Work on this standard was initiated in 1928 by the Committee on Manufacturing Risks and Special Hazards. The standard was first adopted in 1929 and was revised in 1933, 1939, 1940, 1941, 1942 (January and May), 1945, 1946, 1948, 1949, 1956, 1957, 1961, 1962, 1963, 1964, 1966, 1968, 1972, 1973, 1977, and 1980. Revisions adopted between 1945 and 1949 were proposed by the Committee on Special Extinguishing Systems, and those in 1956 and subsequent revisions were proposed by the Committee on Carbon Dioxide. The standard was revised in 1985 and 1989.

The standard was completely rewritten for the 1993 revision to more clearly state the requirements and to separate the mandatory requirements from the advisory text in an effort to make the document more usable, enforceable, and adoptable.

The standard was revised for the 1998 edition and again in 2000 in order to add a new chapter for marine systems.

The 2005 edition of this standard was revised with a focus on safety.

The 2008 edition of the standard was a partial revision.

The 2015 edition incorporated a general update of references and other minor improvements. In addition, a new system acceptance report was added to permit compliance with the commissioning procedures of NFPA 3.

The 2018 edition introduces a new requirement to conduct testing of integrated fire protection and life safety systems in accordance with NFPA 4. In addition, a new section on pipe hangers and supports and a new annex section on full discharge testing have also been added. Finally, the equivalency statement was revised to use the standard text, which specifies that the authority having jurisdiction is responsible for approving an equivalent system, method, or device.

## Technical Committee on Gaseous Fire Extinguishing Systems

**Brent S. Ehmke**, *Chair*  
Ehmke Associates, NC [SE]

**Ronald C. Adcock**, *Secretary*  
Marsh Risk Consulting, AZ [I]

**Katherine Adrian**, Tyco Fire Suppression & Building Products, WI [M]

**Paul Anastasia**, American International Group, Inc. (AIG), MA [I]

**Oded Aron**, Port Authority of New York & New Jersey, NY [U]

**John E. Dellogono**, Liberty Mutual Property, MA [I]

**Todd A. Dillon**, Global Asset Protection Services, LLC, OH [I]

**Laurence E. Fisher**, U.S. Coast Guard, DC [E]

**William A. Froh**, U.S. Department of Energy, DC [U]

**Raymond N. Hansen**, U.S. Department of the Air Force, FL [E]

**Jeffrey L. Harrington**, Harrington Group, Inc., GA [SE]

**Mark E. Herzog**, The Hiller Companies, AL [IM]

**Scott A. Hill**, JENSEN HUGHES, MD [SE]

**Steven Hodges**, Alion Science And Technology, CA [U]

**W. David Hoffman**, Firetrace International, AZ [M]

**Giuliano Indovino**, North American Fire Guardian Technology, Inc., Italy [M]

**Robert Kasiski**, FM Global, MA [I]

**Norbert W. Makowka**, National Association of Fire Equipment Distributors, IL [IM]

Rep. National Association of Fire Equipment Distributors

**Bella A. Maranon**, U.S. Environmental Protection Agency, DC [E]

**Robert G. Richard**, Honeywell, Inc., NY [M]

**Paul E. Rivers**, 3M Company, MN [M]

**Mark L. Robin**, Chemours, DE [M]

**Joseph A. Senecal**, Kidde-Fenwal, Inc., MA [M]

**Blake M. Shugarman**, UL LLC, IL [RT]

**John C. Spalding**, Healey Fire Protection, Inc., MI [M]

Rep. Fire Suppression Systems Association

**Brad T. Stilwell**, Fike Corporation, MO [M]

**Robert T. Wickham**, Wickham Associates, NH [SE]

**Thomas J. Wysocki**, Guardian Services, Inc., IL [SE]

### Alternates

**Maurizio Barbuzzi**, North American Fire Guardian Technology, Inc., Italy [M]

(Alt. to Giuliano Indovino)

**Charles O. Bauroth**, Liberty Mutual, MA [I]

(Alt. to John E. Dellogono)

**Thomas A. Downey**, Marsh Risk Consulting, CT [I]

**Mark E. Fessenden**, Tyco Fire Protection Products, WI [M]

(Alt. to Katherine Adrian)

**Eric W. Forssell**, JENSEN HUGHES, MD [SE]

(Alt. to Scott A. Hill)

**Ryan Gamboa**, Firetrace USA, AZ [M]

(Alt. to W. David Hoffman)

**Kevin Holly, Jr.**, UL LLC, IL [RT]

(Alt. to Blake M. Shugarman)

**Daniel J. Hubert**, Amerex/Janus Fire Systems, IN [M]

(Alt. to John C. Spalding)

**Jonathan G. Ingram**, Kidde-Fenwal, Inc., MA [M]

(Alt. to Joseph A. Senecal)

**Jeffrey S. Kidd**, The Hiller Companies, MA [IM]

(Alt. to Mark E. Herzog)

**Justin D. Merrick**, S&S Sprinkler Company, LLC, AL [M]

Voting Alternate

**Michael Lee Moberly**, BP Upstream Engineering Center, TX [U]

Voting Alternate

**Earl D. Neargarth**, Fike Corporation, MO [M]

(Alt. to Brad T. Stilwell)

**John G. Owens**, 3M Company, MN [M]

(Alt. to Paul E. Rivers)

**James M. Rucci**, Harrington Group, Inc., GA [SE]

(Alt. to Jeffrey L. Harrington)

**Raymond A. Stacy**, FM Approvals, MA [I]

(Alt. to Robert Kasiski)

**Sangeetha Subramanian**, Honeywell, NJ [M]

(Alt. to Robert G. Richard)

**Charles Taylor**, U.S. Coast Guard, DC [E]

(Alt. to Laurence E. Fisher)

**Alfred J. Thornton**, The Chemours Company, DE [M]

(Alt. to Mark L. Robin)

**Todd W. VanGorder**, Silco Fire & Security, OH [IM]

(Alt. to Norbert W. Makowka)

### Nonvoting

**Ingeborg Schlosser**, VdS Schadenverhuetung, Germany [I]

**Fernando Vigara**, APICI, Spain [SE]

**Barry D. Chase**, NFPA Staff Liaison

*This list represents the membership at the time the Committee was balloted on the final text of this edition. Since that time, changes in the membership may have occurred. A key to classifications is found at the back of the document.*

NOTE: Membership on a committee shall not in and of itself constitute an endorsement of the Association or any document developed by the committee on which the member serves.

**Committee Scope:** This committee shall have primary responsibility for documents on the installation, maintenance, and use of carbon dioxide systems for fire protection.

This committee shall also have primary responsibility for documents on fixed fire extinguishing systems utilizing bromotrifluoromethane and other similar halogenated extinguishing agents, covering the installation, maintenance, and use of systems.

This committee shall also have primary responsibility for documents on alternative protection options to Halon 1301 and 1211 fire extinguishing systems. It shall not deal with design, installation, operation, testing, and maintenance of systems employing dry chemical, wet chemical, foam, aerosols, or water as the primary extinguishing media.

## Contents

<b>Chapter 1 Administration</b> .....	12- 5	6.4 Rate-by-Area Method. ....	12- 23
1.1 Scope. ....	12- 5	6.5 Rate-by-Volume Method. ....	12- 24
1.2 Purpose. ....	12- 5	6.6 Distribution System. ....	12- 25
1.3 Retroactivity. ....	12- 5		
1.4 Units. ....	12- 5	<b>Chapter 7 Hand Hose Line Systems</b> .....	12- 25
<b>Chapter 2 Referenced Publications</b> .....	12- 5	7.1 General Information. ....	12- 25
2.1 General. ....	12- 5	7.2 Hazard Specifications. ....	12- 25
2.2 NFPA Publications. ....	12- 5	7.3 Location and Spacing. ....	12- 25
2.3 Other Publications. ....	12- 5	7.4 Carbon Dioxide Requirements. ....	12- 25
2.4 References for Extracts in Mandatory Sections. ...	12- 6	7.5 Equipment Specifications. ....	12- 25
<b>Chapter 3 Definitions</b> .....	12- 6	7.6 Training. ....	12- 26
3.1 General. ....	12- 6	<b>Chapter 8 Standpipe Systems and Mobile Supply</b> .....	12- 26
3.2 NFPA Official Definitions. ....	12- 6	8.1 General Information. ....	12- 26
3.3 General Definitions. ....	12- 6	8.2 Hazard Specifications. ....	12- 26
3.4 Special Definitions. ....	12- 7	8.3 Standpipe Requirements. ....	12- 26
<b>Chapter 4 General Information</b> .....	12- 7	8.4 Mobile Supply Requirements. ....	12- 26
4.1 Restrictions for Normally Occupied Enclosures. ...	12- 7	8.5 Training. ....	12- 26
4.2 Carbon Dioxide Use and Limitations. ....	12- 7	<b>Chapter 9 Marine Systems</b> .....	12- 26
4.3 Personnel Safety. ....	12- 8	9.1 Special Definitions. ....	12- 26
4.4 Specifications, Plans, and Approvals. ....	12- 10	9.2 General. ....	12- 26
4.5 Detection, Actuation, and Control. ....	12- 11	9.3 System Requirements. ....	12- 26
4.6 Carbon Dioxide Supply. ....	12- 14	9.4 Inspection and Maintenance. ....	12- 28
4.7 Distribution Systems. ....	12- 15	<b>Annex A Explanatory Material</b> .....	12- 28
4.8 Inspection, Maintenance, and Instruction. ....	12- 18	<b>Annex B Examples of Hazard Protection</b> .....	12- 43
<b>Chapter 5 Total Flooding Systems</b> .....	12- 18	<b>Annex C Pipe and Orifice Size Determination</b> .....	12- 46
5.1 General Information. ....	12- 18	<b>Annex D Total Flooding Systems</b> .....	12- 52
5.2 Hazard Specifications. ....	12- 19	<b>Annex E Surface Fires</b> .....	12- 54
5.3 Carbon Dioxide Requirements for Surface Fires. ....	12- 19	<b>Annex F Local Application Carbon Dioxide Systems</b> .	12- 56
5.4 Carbon Dioxide Requirements for Deep-Seated Fires. ....	12- 21	<b>Annex G General Information on Carbon Dioxide</b> ....	12- 58
5.5 Distribution System. ....	12- 21	<b>Annex H Informational References</b> .....	12- 60
5.6 Venting Consideration. ....	12- 22	<b>Index</b> .....	12- 61
<b>Chapter 6 Local Application Systems</b> .....	12- 22		
6.1 General Information. ....	12- 22		
6.2 Hazard Specifications. ....	12- 22		
6.3 Carbon Dioxide Requirements. ....	12- 23		



NFPA 12

Standard on

Carbon Dioxide Extinguishing Systems

2018 Edition

**IMPORTANT NOTE:** This NFPA document is made available for use subject to important notices and legal disclaimers. These notices and disclaimers appear in all publications containing this document and may be found under the heading “Important Notices and Disclaimers Concerning NFPA Standards.” They can also be viewed at [www.nfpa.org/disclaimers](http://www.nfpa.org/disclaimers) or obtained on request from NFPA.

**UPDATES, ALERTS, AND FUTURE EDITIONS:** New editions of NFPA codes, standards, recommended practices, and guides (i.e., NFPA Standards) are released on scheduled revision cycles. This edition may be superseded by a later one, or it may be amended outside of its scheduled revision cycle through the issuance of Tentative Interim Amendments (TIAs). An official NFPA Standard at any point in time consists of the current edition of the document, together with all TIAs and Errata in effect. To verify that this document is the current edition or to determine if it has been amended by TIAs or Errata, please consult the National Fire Codes® Subscription Service or the “List of NFPA Codes & Standards” at [www.nfpa.org/docinfo](http://www.nfpa.org/docinfo). In addition to TIAs and Errata, the document information pages also include the option to sign up for alerts for individual documents and to be involved in the development of the next edition.

**NOTICE:** An asterisk (\*) following the number or letter designating a paragraph indicates that explanatory material on the paragraph can be found in Annex A.

A reference in brackets [ ] following a section or paragraph indicates material that has been extracted from another NFPA document. As an aid to the user, the complete title and edition of the source documents for extracts in mandatory sections of the document are given in Chapter 2 and those for extracts in informational sections are given in Annex H. Extracted text may be edited for consistency and style and may include the revision of internal paragraph references and other references as appropriate. Requests for interpretations or revisions of extracted text shall be sent to the technical committee responsible for the source document.

Information on referenced publications can be found in Chapter 2 and Annex H.

Chapter 1 Administration

1.1\* Scope.

1.1.1 This standard contains minimum requirements for carbon dioxide fire-extinguishing systems.

1.1.2 This standard includes only the necessary essentials to make it workable in the hands of those skilled in this field.

1.2 Purpose.

1.2.1 This standard is prepared for the use and guidance of those charged with the purchasing, designing, installing, testing, inspecting, approving, listing, operating, or maintaining of carbon dioxide fire-extinguishing systems, in order that such equipment will function as intended throughout its life.

1.2.2 **Equivalency.** Nothing in this standard is intended to prevent the use of systems, methods, or devices of equivalent or

superior quality, strength, fire resistance, effectiveness, durability, and safety over those prescribed by this standard.

**N 1.2.2.1** Technical documentation shall be submitted to the authority having jurisdiction to demonstrate equivalency.

**N 1.2.2.2** The system, method, or device shall be approved for the intended purpose by the authority having jurisdiction.

1.2.3 Only those with the proper training and experience shall design, install, inspect, and maintain this equipment.

**1.3 Retroactivity.** The provisions of this standard reflect a consensus of what is necessary to provide an acceptable degree of protection from the hazards addressed in this standard at the time the standard was issued.

1.3.1 Unless otherwise specified, the provisions of this standard shall not apply to facilities, equipment, structures, or installations that existed or were approved for construction or installation prior to the effective date of the standard. Where specified, the provisions of this standard shall be retroactive.

1.3.2 In those cases where the authority having jurisdiction determines that the existing situation presents an unacceptable degree of risk, the authority having jurisdiction shall be permitted to apply retroactively any portions of this standard deemed appropriate.

1.3.3 The retroactive requirements of this standard shall be permitted to be modified if their application clearly would be impractical in the judgment of the authority having jurisdiction and only where it is clearly evident that a reasonable degree of safety is provided.

**Δ 1.3.4\*** Existing systems shall meet the requirements for safety signs in 4.3.2, lockout valves in 4.3.3.4 and 4.3.3.4.1, and pneumatic time delays and pneumatic predischARGE alarms in 4.5.6.2.

**• 1.4\* Units.** Metric units of measurement in this standard are in accordance with the modernized metric system known as the International System of Units (SI).

Chapter 2 Referenced Publications

**2.1 General.** The documents or portions thereof listed in this chapter are referenced within this standard and shall be considered part of the requirements of this document.

**2.2 NFPA Publications.** National Fire Protection Association, 1 Batterymarch Park, Quincy, MA 02169-7471.

NFPA 4, *Standard for Integrated Fire Protection and Life Safety System Testing*, 2018 edition.

NFPA 70®, *National Electrical Code*®, 2017 edition.

NFPA 72®, *National Fire Alarm and Signaling Code*®, 2016 edition.

**2.3 Other Publications.**

**2.3.1 ANSI Publications.** American National Standards Institute, Inc., 25 West 43rd Street, 4th Floor, New York, NY 10036.

ANSI Z535.2, *Standard for Environmental and Facility Safety Signs*, 2011.



**2.3.2 API Publications.** American Petroleum Institute, 1220 L Street, NW, Washington, DC 20005-4070.

API-ASME *Code for Unfired Pressure Vessels for Petroleum Liquids and Gases*, Pre-July 1, 1961.

**2.3.3 ASME Publications.** American Society of Mechanical Engineers, Two Park Avenue, New York, NY 10016-5990.

ASME B31.1, *Power Piping Code*, 2016.

**2.3.4 ASTM Publications.** ASTM International, 100 Barr Harbor Drive, P.O. Box C700, West Conshohocken, PA 19428-2959.

ASTM A53/A53M, *Standard Specification for Pipe, Steel, Black and Hot-Dipped, Zinc-Coated, Welded and Seamless*, 2012.

ASTM A106/A106M, *Standard Specification for Seamless Carbon Steel Pipe for High-Temperature Service*, 2015.

ASTM A120, *Specification for Pipe, Steel, Black and Hot-Dipped Zinc-Coated (Galvanized) Welded and Seamless for Ordinary Uses*, 1984 (withdrawn 1987).

ASTM A182/A182M, *Standard Specification for Forged or Rolled Alloy and Stainless Steel Pipe Flanges, Forged Fittings, and Valves and Parts for High-Temperature Service*, 2016.

**2.3.5 CGA Publications.** Compressed Gas Association, 14501 George Carter Way, Suite 103, Chantilly, VA 20151-2923.

CGA G-6.2, *Commodity Specification for Carbon Dioxide*, 2011.

**2.3.6 CSA Group Publications.** CSA Group, 178 Rexdale Blvd., Toronto, ON M9W 1R3, Canada.

CSA C22.1, *Canadian Electrical Code*, 2015.

**N 2.3.7 IEEE Publications.** IEEE, 3 Park Avenue, 17th Floor, New York, NY 10016-5997.

ANSI/IEEE C2, *National Electrical Safety Code*, 2017.

**2.3.8 U.S. Government Publications.** U.S. Government Publishing Office, 732 North Capitol Street, NW, Washington, DC 20401-0001.

Title 46, Code of Federal Regulations, Part 58.20.

Title 46, Code of Federal Regulations, Part 72.

Title 49, Code of Federal Regulations, Parts 171–190 (Department of Transportation).

Coward, H. F., and G. W. Jones, *Limits of Flammability of Gases and Vapors*, U.S. Bureau of Mines Bulletin 503, 1952.

Zabetakis, Michael G., *Flammability Characteristics of Combustible Gases and Vapors*, U.S. Bureau of Mines Bulletin 627, 1965.

**2.3.9 Other Publications.**

*Merriam-Webster's Collegiate Dictionary*, 11th edition, Merriam-Webster, Inc., Springfield, MA, 2003.

**2.4 References for Extracts in Mandatory Sections.**

NFPA 1, *Fire Code*, 2018 edition.

NFPA 122, *Standard for Fire Prevention and Control in Metal/Nonmetal Mining and Metal Mineral Processing Facilities*, 2015 edition.

NFPA 820, *Standard for Fire Protection in Wastewater Treatment and Collection Facilities*, 2016 edition.

## Chapter 3 Definitions

**3.1 General.** The definitions contained in this chapter shall apply to the terms used in this standard. Where terms are not defined in this chapter or within another chapter, they shall be defined using their ordinarily accepted meanings within the context in which they are used. *Merriam-Webster's Collegiate Dictionary*, 11th edition, shall be the source for the ordinarily accepted meaning.

**3.2 NFPA Official Definitions.**

**3.2.1\* Approved.** Acceptable to the authority having jurisdiction.

**3.2.2\* Authority Having Jurisdiction (AHJ).** An organization, office, or individual responsible for enforcing the requirements of a code or standard, or for approving equipment, materials, an installation, or a procedure.

**3.2.3 Labeled.** Equipment or materials to which has been attached a label, symbol, or other identifying mark of an organization that is acceptable to the authority having jurisdiction and concerned with product evaluation, that maintains periodic inspection of production of labeled equipment or materials, and by whose labeling the manufacturer indicates compliance with appropriate standards or performance in a specified manner.

**3.2.4\* Listed.** Equipment, materials, or services included in a list published by an organization that is acceptable to the authority having jurisdiction and concerned with evaluation of products or services, that maintains periodic inspection of production of listed equipment or materials or periodic evaluation of services, and whose listing states that either the equipment, material, or service meets appropriate designated standards or has been tested and found suitable for a specified purpose.

**3.2.5 Shall.** Indicates a mandatory requirement.

**3.2.6 Should.** Indicates a recommendation or that which is advised but not required.

**3.2.7 Standard.** An NFPA Standard, the main text of which contains only mandatory provisions using the word “shall” to indicate requirements and that is in a form generally suitable for mandatory reference by another standard or code or for adoption into law. Nonmandatory provisions are not to be considered a part of the requirements of a standard and shall be located in an appendix, annex, footnote, informational note, or other means as permitted in the NFPA Manuals of Style. When used in a generic sense, such as in the phrase “standards development process” or “standards development activities,” the term “standards” includes all NFPA Standards, including Codes, Standards, Recommended Practices, and Guides.

**3.3 General Definitions.**

**3.3.1 Alarms and Indicators.** Any device capable of providing audible, visible, or olfactory indication.

**Δ 3.3.2 Fire Watch.** The assignment of a person or persons to an area for the express purpose of notifying the fire department, the building occupants, or both of an emergency; preventing a fire from occurring; extinguishing small fires; protecting the public from fire and life safety dangers. [1, 2018].

**3.3.3 Inspection.** A visual examination of a system or portion thereof to verify that it appears to be in operating condition and is free of physical damage. [820, 2016]

**3.3.4 Lockout.** A manually operated valve in the discharge pipe between the nozzles and the supply, which can be locked in the closed position to prevent flow of carbon dioxide to the protected area.

**3.3.5 Maintenance.** Work performed to ensure that equipment operates as directed by the manufacturer.

**3.3.6 Normally Occupied Enclosure or Space.** An enclosure or space where one or more persons are present under normal circumstances.

**3.3.7\* Normally Unoccupied Enclosure or Space.** An enclosure or space not normally occupied but one that could be entered occasionally by one or more persons for brief periods.

**3.3.8 Occupiable Enclosure or Space.** An enclosure or space that has dimensions and physical characteristics such that it could be entered by a person.

### 3.3.9 Pressure.

**3.3.9.1\* High Pressure.** Indicates that the carbon dioxide is stored in pressure containers at ambient temperatures.

**3.3.9.2\* Low Pressure.** Indicates that the carbon dioxide is stored in pressure containers at a controlled low temperature of 0°F (-18°C).

**3.3.10 Standpipe System and Mobile Supply.** A system consisting of a mobile supply of carbon dioxide, designed to be quickly moved into position and connected to a system of fixed piping, supplying fixed nozzles or hose lines or both that are designed for either total flooding or local application.

### 3.3.11 System.

**3.3.11.1 Hand Hose Line System.** A hose and nozzle assembly connected by fixed piping or connected directly to a supply of extinguishing agent. [122, 2015]

**3.3.11.2 Local Application System.** A system consisting of a supply of extinguishing agent arranged to discharge directly on the burning material.

**3.3.11.3\* Pre-Engineered System.** A system that has predetermined flow rates, nozzle placement, and quantities of carbon dioxide and that incorporates specific nozzles and methods of application that can differ from those detailed elsewhere in this standard and those that are listed by a testing laboratory.

**3.3.11.4 Total Flooding System.** A system consisting of a supply of carbon dioxide arranged to discharge into, and fill to the proper concentration, an enclosed space or enclosure around the hazard.

**3.3.12 Unoccupiable Enclosure or Space.** An enclosure or space that has dimensions and physical characteristics such that it could not be entered by a person.

## 3.4 Special Definitions.

**3.4.1 Marine Systems.** Systems installed on ships, barges, offshore platforms, motorboats, and pleasure craft.

## 3.4.2 Marine System Spaces.

**3.4.2.1 Cargo Space.** A space for the carriage or storage of items or products that are transported by the vessel.

**3.4.2.2 Electrical Equipment Space.** A space containing electrical propulsion, power generating, or power distribution equipment.

**3.4.2.3 Machinery Space.** A space that contains mechanical equipment for handling, pumping, or transferring flammable or combustible liquids as a fuel.

**3.4.2.4 Vehicle Space.** A space that is designed for the carriage of automobiles or other self-propelled vehicles.

## Chapter 4 General Information

### 4.1 Restrictions for Normally Occupied Enclosures.

**4.1.1** New total flooding carbon dioxide systems shall not be installed in normally occupied enclosures except as permitted in 4.1.1.1, 4.1.1.2, 4.1.1.3, 4.1.1.4, or 4.1.1.5.

**4.1.1.1** New total flooding carbon dioxide systems shall be permitted to be installed in normally occupied enclosures where it is determined that an inerting concentration is required and the inerting concentration required using alternate gaseous agents results in a concentration above the lowest observed adverse effect level (LOAEL) or the oxygen concentration is less than 8 percent.

**4.1.1.2** New total flooding carbon dioxide systems shall be permitted to be installed in normally occupied enclosures for fires involving energized electrical equipment >400 volts and grouped electrical cables where no gaseous alternative agent has been successfully tested.

**4.1.1.3** New total flooding carbon dioxide systems shall be permitted to be installed in normally occupied enclosures where design methods or hardware, or both, for unencloseable openings or extended discharge are not available for other gaseous agents.

**4.1.1.4** New total flooding carbon dioxide systems shall be permitted to be installed in marine cargo holds.

**4.1.1.5** New total flooding carbon dioxide systems shall be permitted to be installed in normally occupied enclosures in marine engine rooms where it is determined that an inerting concentration is required and the inerting concentration required using alternate gaseous agents results in a concentration above the LOAEL or the oxygen concentration is less than 8 percent.

**4.1.2 Existing Systems.** Existing total flooding carbon dioxide systems shall be permitted in normally occupied enclosures equipped with system lockout valves, pneumatic predischARGE alarms, and pneumatic time delays specified in 4.5.6.

**4.2 Carbon Dioxide Use and Limitations.** See also Annex G.

**4.2.1\*** Carbon dioxide fire-extinguishing systems protecting areas where explosive atmospheres could exist shall utilize metal nozzles, and the entire system shall be grounded.

**4.2.2** In addition, objects exposed to discharge from carbon dioxide nozzles shall be grounded to dissipate possible electrostatic charges.

### 4.3\* Personnel Safety.

#### 4.3.1\* Hazards to Personnel.

4.3.1.1 Consideration shall be given to the possibility of carbon dioxide drifting and settling into adjacent places outside the protected space. (See 4.3.1.3.)

4.3.1.2 Consideration shall also be given to where the carbon dioxide can migrate or collect in the event of a discharge from a safety relief device of a storage container.

4.3.1.3\* In any use of carbon dioxide, consideration shall be given to the possibility that personnel could be trapped in or enter into an atmosphere made hazardous by a carbon dioxide discharge.

4.3.1.3.1 Safeguards shall be provided to ensure prompt evacuation, to prevent entry into such atmospheres as described in 4.3.1.3, and to provide means for prompt rescue of any trapped personnel.

4.3.1.3.2 Personnel training shall be provided.

#### 4.3.2 Signs.

4.3.2.1 Warning signs shall be affixed in a conspicuous location in every protected space; at every entrance to protected spaces; in spaces near the protected spaces where it is determined that carbon dioxide could migrate, creating a hazard to personnel; and at each entrance to carbon dioxide storage rooms and where carbon dioxide can migrate or collect in the event of a discharge from a safety device of a storage container.

4.3.2.2 The safety sign format, color, letter style of signal words, message panel lettering, lettering size, and the safety provisions of symbols shall be in accordance with ANSI Z535.2.

4.3.2.3 Safety signs and message wording shall be provided using a three-panel format as required by 4.3.2.3.1 through 4.3.2.3.6.2.

4.3.2.3.1 The sign in Figure 4.3.2.3.1 shall be used in every protected space.

4.3.2.3.2 The sign in Figure 4.3.2.3.2 shall be used at every entrance to protected space.

4.3.2.3.3 The sign in Figure 4.3.2.3.3 shall be used at every entrance to protected space for systems provided with a wintergreen odorizer.

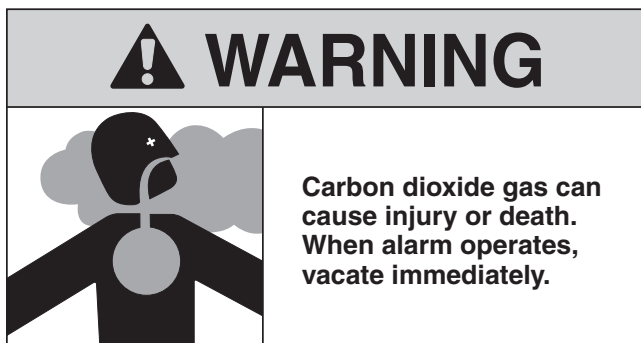

FIGURE 4.3.2.3.1 Sign in Every Protected Space.

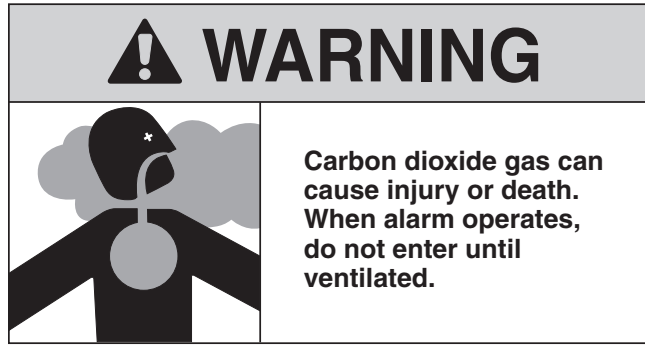

FIGURE 4.3.2.3.2 Sign at Every Entrance to Protected Space.

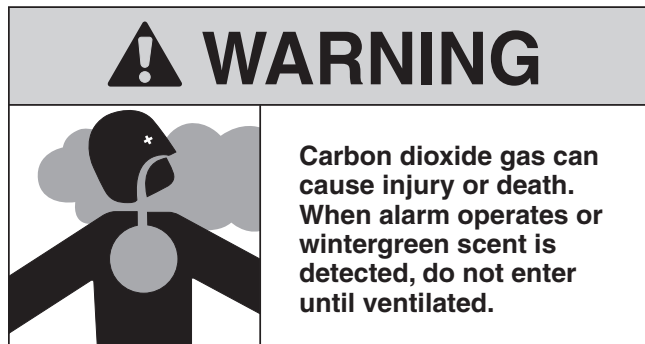

FIGURE 4.3.2.3.3 Sign at Every Entrance to Protected Space for Systems Provided with a Wintergreen Odorizer.

4.3.2.3.4 The sign in Figure 4.3.2.3.4 shall be used in every nearby space where carbon dioxide could accumulate to hazardous levels.

4.3.2.3.5 The sign in Figure 4.3.2.3.5 shall be used outside each entrance to carbon dioxide storage rooms.

#### 4.3.2.3.6 Signs for Manual Operation.

4.3.2.3.6.1 Warning signs shall be placed at every location where manual operation of the system could occur.

4.3.2.3.6.2 The sign in Figure 4.3.2.3.6.2 shall be used at each manual actuation station.

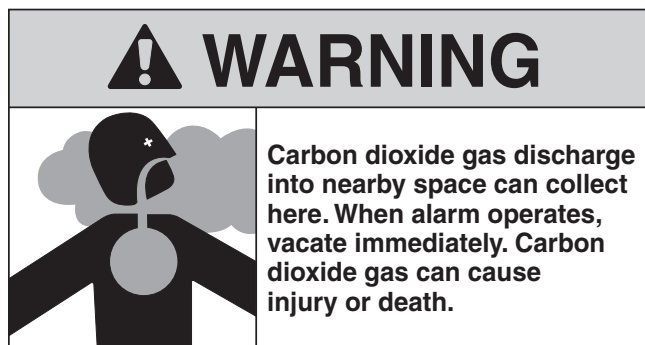

FIGURE 4.3.2.3.4 Sign in Every Nearby Space Where Carbon Dioxide Could Accumulate to Hazardous Levels.

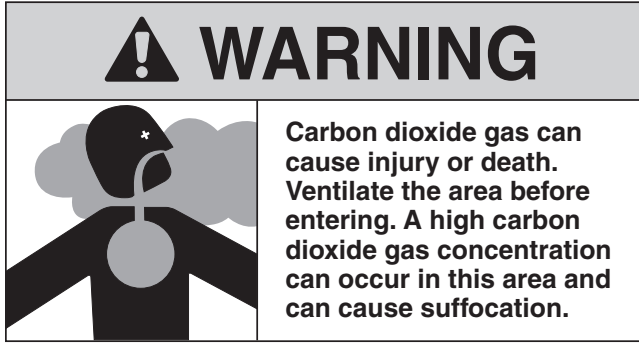

FIGURE 4.3.2.3.5 Sign Outside Each Entrance to Carbon Dioxide Storage Rooms.

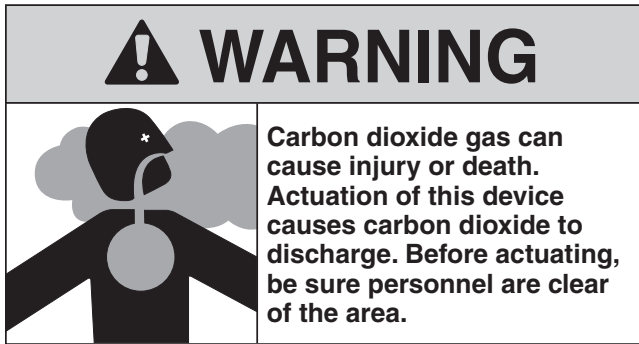

FIGURE 4.3.2.3.6.2 Sign at Each Manual Actuation Station.

**4.3.2.4** For installations that have existing signs that differ from those required by 4.3.2.3 but that meet the requirements of 4.3.2.1, the existing signage shall be considered acceptable if the facility has a signage training program in place covering all suppression system-related signage, with all personnel with access to the protected space either trained on the signage or accompanied when in the protected space at all times by a person who has received the training required. New installations in facilities covered by this paragraph shall be equipped with the same type of signage as used in existing signage in the facility. All signs within the facility shall have the same style and format.

### 4.3.3 Evacuation Procedures.

**4.3.3.1** All persons who can at any time enter a space protected by carbon dioxide shall be warned of the hazards involved and provided with safe evacuation procedures.

**4.3.3.1.1** Provisions shall be made to prohibit entry of unprotected personnel to spaces made unsafe by a carbon dioxide discharge until the space is ventilated and appropriate tests of the atmosphere have verified that it is safe for unprotected persons to enter. Persons who are not properly trained in the use of and equipped with self-contained breathing apparatus (SCBA) shall not remain in spaces where the concentration exceeds 4 percent.

**4.3.3.2** Audible and visible alarms shall be provided in accordance with 4.5.6.

**4.3.3.3\*** All personnel shall be informed that discharge of carbon dioxide gas from either high- or low-pressure systems

directly at a person will endanger the person's safety by causing eye injury, ear injury, or even falls due to loss of balance upon the impingement of the high-velocity discharging gas.

**4.3.3.4** A lockout shall be provided on all systems except where dimensional constraints prevent personnel from entering the protected space.

**4.3.3.4.1** Lockout valves shall be installed on all systems where carbon dioxide could migrate, creating a hazard to personnel.

**4.3.3.4.2** In a low-pressure system, the tank shutoff valve shall not be considered as a lockout valve, except as permitted by 4.3.3.4.3.

**4.3.3.4.3** Where a single low-pressure storage tank supplies single or multiple systems protecting interrelated hazards, and when none of the hazards require protection if the equipment being protected is shut down, the storage tank shutoff valve shall be permitted to be used as a lockout valve for the entire system.

**4.3.3.4.4\*** A service disconnect switch shall not be used as a means of preventing agent discharge in lieu of a lockout valve. (See 4.5.4.12.)

**4.3.3.4.5** When maintenance or testing is being conducted on the system, it shall be locked out, or the protected space and affected spaces (migration) shall be evacuated.

**4.3.3.4.6** When protection is to be maintained during the lockout period, a person(s) shall be assigned as a "fire watch" with suitable portable or semiportable fire-fighting equipment or means to restore protection.

**4.3.3.4.6.1** The fire watch shall have a communication link to a constantly monitored location.

**4.3.3.4.6.2** Authorities responsible for continuity of fire protection shall be notified of the lockout and subsequent restoration of the system.

**4.3.3.5\*** Safe handling procedures shall be followed when transporting system cylinders.

### 4.3.4 Electrical Clearances.

**4.3.4.1\*** All system components shall be located so as to maintain minimum clearances from live parts as shown in Table 4.3.4.1 and Figure 4.3.4.1.

**4.3.4.2\*** At altitudes in excess of 3300 ft (1000 m), the clearance from live parts shall be increased at the rate of 1 percent for each 330 ft (100 m) increase in altitude above 3300 ft (1000 m).

**4.3.4.3\*** To coordinate the required clearance with the electrical design, the design basic insulation level (BIL) of the equipment being protected shall be used as a basis, although this is not material at nominal line voltages of 161 kV or less.

**4.3.4.4\*** The selected clearance to ground shall satisfy the greater of switching surge or BIL duty, rather than be based on nominal voltage.

**4.3.4.5** The clearance between uninsulated energized parts of the electrical system equipment and any portion of the carbon dioxide system shall be not less than the minimum clearance provided elsewhere for electrical system insulations on any individual component.

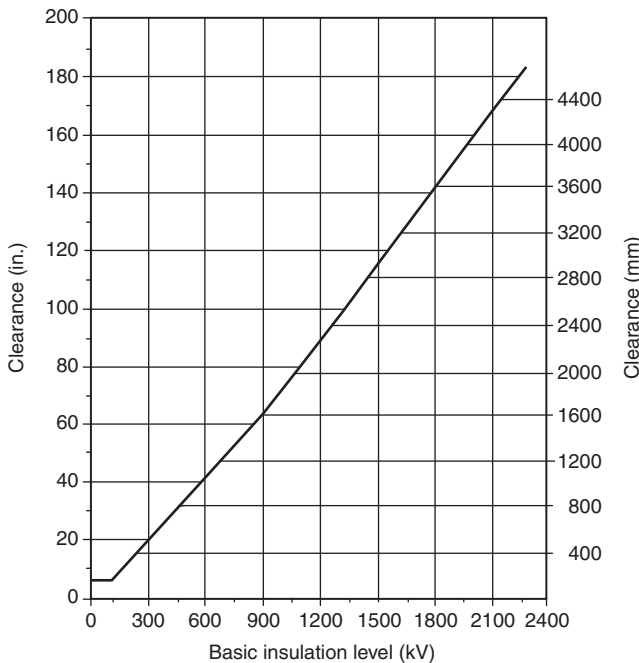

**Table 4.3.4.1 Clearance from Carbon Dioxide Equipment to Live Uninsulated Electrical Components**

Nominal System Voltage (kV)	Maximum System Voltage (kV)	Design BIL* (kV)	Minimum† Clearance	
			in.	mm
≤13.8	14.5	110	7	178
≤23.0	24.3	150	10	254
≤34.5	36.5	200	13	330
≤46.0	48.3	250	17	432
≤69.0	72.5	350	25	635
≤115.0	21.0	550	42	1067
≤138.0	145.0	650	50	1270
≤161.0	169.0	750	58	1473
≤230.0	242.0	900	76	1930
		1050	84	2134
≤345.0	362.0	1050	84	2134
		1300	104	2642
≤500.0	550.0	1500	124	3150
		1800	144	3658
≤765.0	800.0	2050	167	4242

\*Basic insulation level (BIL) values are expressed as kilovolts (kV), the number being the crest value of the full wave impulse test that the electrical equipment is designed to withstand. For BIL values that are not listed in the table, clearances can be found by interpolation.

†For voltages up to 161 kV, the clearances are taken from *NFPA 70*. For voltages 230 kV and above, the clearances are taken from Table 124 of ANSI/IEEE C2. In Canada, refer to CSA C22.1.



**FIGURE 4.3.4.1 Clearance from Carbon Dioxide Equipment to Live Uninsulated Electrical Components.**

4.3.4.6 When the design BIL is not available, and when nominal voltage is used for the design criteria, the highest minimum clearance listed for this group shall be used.

4.3.5\* **Duration of Protection.** An effective agent concentration for total flooding systems shall be achieved and maintained for a period of time to allow effective emergency action by trained personnel.

4.3.6\* Visible predischage alarms shall comply with the following:

- (1) They shall be visible throughout the protected space.
- (2) They shall be distinct from the building fire alarm signal and other alarm signals.
- (3) Visible appliances, except for strobes, shall not be required to be synchronized with each other or with the building fire alarms.

**4.4 Specifications, Plans, and Approvals.**

**4.4.1 Specifications.**

4.4.1.1 Specifications for carbon dioxide fire-extinguishing systems shall be prepared under the supervision of a person fully experienced and qualified in the design of carbon dioxide extinguishing systems and with the advice of the authority having jurisdiction.

4.4.1.2 The specifications shall include all pertinent items necessary for the design of the system such as the designation of the authority having jurisdiction, variances from the standard to be permitted by the authority having jurisdiction, and the type and extent of approval testing to be performed after installation of the system.

**N** 4.4.1.3 Integrated fire protection and life safety system testing shall be in accordance with NFPA 4.

**4.4.2 Plans.**

4.4.2.1 Plans and calculations shall be submitted for approval to the authority having jurisdiction before the installation begins.

4.4.2.2 Plans and calculations shall be prepared by persons fully qualified in the design of carbon dioxide fire-extinguishing systems.

4.4.2.3 These plans shall be drawn to an indicated scale or be dimensioned.

4.4.2.4 The plans shall be so made that they can be easily reproduced.

4.4.2.5 These plans shall contain sufficient detail to enable the authority having jurisdiction to evaluate the hazard or hazards and to evaluate the effectiveness of the system.

4.4.2.6 The details of the plans shall include the following:

- (1) Materials involved in the protected hazards
- (2) Location of the hazards
- (3) Enclosure or limits and isolation of the hazards
- (4) Surrounding area that could affect the protected hazards

4.4.2.7 The details on the system shall include the following:

- (1) Information and calculations on the amount of carbon dioxide
- (2) Location and flow rate of each nozzle, including orifice code number and actual orifice diameter

- (3) Location, size, and equivalent lengths of pipe, fittings, and hose
- (4) Location and size of the carbon dioxide storage facility

**4.4.2.8** Details of pipe size reduction method (reducing couplings or bushings) and orientation of tees shall be clearly indicated.

**4.4.2.9** Information shall be submitted pertaining to the location and function of the detection devices, operating devices, auxiliary equipment, and electrical circuitry, if used.

**4.4.2.10** Information shall be indicated to identify the apparatus and devices used.

**4.4.2.11** Any special features shall be adequately explained.

**4.4.2.12** When field conditions necessitate any substantial change from approved plans, the change shall be submitted to the authority having jurisdiction for approval.

**4.4.2.13** If the final installation varies from the prepared drawings and calculations, new drawings and calculations representing the “as-built” installation shall be prepared.

**4.4.2.13.1** As-built drawings shall indicate interconnections of required equipment shutdowns and fuel shutoffs with the fire extinguishing system.

**4.4.2.14** The system owner shall maintain an instruction and maintenance manual that includes a full sequence of operation, and a full set of system drawings and calculations shall be maintained in a protective enclosure.

#### **4.4.3\* Approval of Installations.**

**4.4.3.1\*** The completed system shall be inspected, tested, and documented by qualified personnel to meet the approval of the authority having jurisdiction.

**4.4.3.1.1** The acceptance testing required by 4.4.3.1 shall be documented in a test report.

**4.4.3.1.2** The acceptance test report shall be maintained by the system owner for the life of the system.

**4.4.3.2\*** Only listed or approved equipment and devices shall be used in the system.

**4.4.3.3** To determine that the system has been properly installed and will function as specified, the procedures given in 4.4.3.3.1 through 4.4.3.3.4.2 shall be performed.

**4.4.3.3.1 Visual Inspection.** A thorough visual inspection of the installed system and hazard area shall be conducted.

**4.4.3.3.1.1** The piping, operational equipment, and discharge nozzles shall be inspected for proper size and location.

**4.4.3.3.1.2** The locations of alarms and manual emergency releases shall be confirmed.

**4.4.3.3.1.3** The configuration of the hazard shall be compared to the original hazard specification.

**4.4.3.3.1.4** The hazard shall be inspected closely for unclosable openings and sources of agent loss that could have been overlooked in the original specification.

#### **4.4.3.3.2 Labeling.**

**4.4.3.3.2.1** A check of labeling of devices for proper designations and instructions shall be performed.

**4.4.3.3.2.2** Nameplate data on the storage containers shall be compared to specifications.

**4.4.3.3.3 Operational Tests.** Nondestructive operational tests on all devices necessary for the functioning of the system, including detection devices, actuation devices, and notification appliances, shall be conducted.

#### **4.4.3.3.4\* Full Discharge Test.**

**4.4.3.3.4.1** A full discharge test shall be performed on all systems.

**4.4.3.3.4.2** Where multiple hazards are protected from a common supply, a full discharge test shall be performed for each hazard.

**4.4.3.4** Prior to testing, safety procedures shall be reviewed. (See Section 4.4.)

**4.4.4 Testing of Systems.** Systems shall be tested as stated in 4.4.4.1 through 4.4.4.3.

**4.4.4.1 Local Application.** A full discharge of the design quantity of carbon dioxide through system piping shall be conducted to ensure that carbon dioxide effectively covers the hazard for the full period of time required by the design specifications and that all pressure-operated devices function as intended.

**4.4.4.2 Total Flooding.** A full discharge of the entire design quantity of carbon dioxide through system piping shall be conducted to ensure that carbon dioxide is discharged into the hazard, that the concentration is achieved and maintained for the period of time required by the design specifications, and that all pressure-operated devices function as intended.

#### **4.4.4.3 Handheld Hose Lines.**

**4.4.4.3.1** A full discharge test of handheld hose line systems shall be conducted.

**4.4.4.3.2** Evidence of liquid flow from each nozzle with an adequate pattern of coverage shall be required.

#### **4.5 Detection, Actuation, and Control.**

**4.5.1 Classification.** Systems shall be classified as automatic or manual in accordance with the methods of actuation described in 4.5.1.1 through 4.5.1.3.2.

**4.5.1.1 Automatic Operation.** Operation that does not require any human action shall be considered automatic operation.

#### **4.5.1.2 Normal Manual Operation.**

**4.5.1.2.1** Operation of the system requiring human action where the location of the device used to cause operation makes it easily accessible at all times to the hazard shall be considered normal manual operation. (See 4.5.4.5.)

**4.5.1.2.2** Operation of one control shall be all that is required to bring about the full operation of the system.

#### **4.5.1.3\* Emergency Manual Operation.**

**4.5.1.3.1** Operation of the system by human means where the device used to cause operation is fully mechanical in nature and is located at or near the device being controlled shall be considered emergency manual operation.

**4.5.1.3.2** A fully mechanical device shall be permitted to incorporate the use of system pressure to complete operation of the device. (See 4.5.4.6.)

**4.5.2\* Automatic Detection and Automatic Actuation.** Automatic detection and automatic actuation shall be used, except in the following situations:

- (1) Manual-only actuation shall be permitted if acceptable to the authority having jurisdiction where automatic release could result in an increased risk.
- (2) Automatic detection and automatic actuation shall not apply to hand hose line and standpipe systems.
- (3) Automatic detection and automatic actuation shall not apply to marine systems except as permitted in 9.3.3.

**4.5.2.1\*** Automatic actuation controls shall be arranged to require a sustained fire alarm initiation signal prior to actuation of predischARGE alarms and to require actuation of any electrically operated predischARGE time delays and electrically operated predischARGE alarms prior to actuation of releasing devices.

**4.5.3\* Automatic Detection.** Automatic detection shall be by any listed or approved method or device that is capable of detecting and indicating heat, flame, smoke, combustible vapors, or an abnormal condition in the hazard such as process trouble that is likely to produce fire.

**4.5.4 Operating Devices.** Operating devices shall include carbon dioxide releasing devices or valves, discharge controls, and equipment shutdown devices, all of which are necessary for successful performance of the system.

#### 4.5.4.1 Listed and Approved.

**4.5.4.1.1** Operation shall be by listed or approved mechanical, electrical, or pneumatic means.

**4.5.4.1.2** The control equipment shall be specifically listed or approved for the number and type of actuating devices utilized, and their compatibility shall be listed or approved.

#### 4.5.4.2 Device Design.

**4.5.4.2.1** All devices shall be designed for the service they will encounter and shall not be readily rendered inoperative or susceptible to accidental operation.

**4.5.4.2.2** Devices shall be normally designed to function from -20°F to 150°F (-29°C to 66°C) or marked to indicate temperature limitations.

**4.5.4.3** All devices shall be located, installed, or protected so that they are not subject to mechanical, chemical, or other damage that would render them inoperative.

**4.5.4.4** Devices with manufacturer-specific connections used to control the release of carbon dioxide shall have connections that are distinctive or distinctively marked where there is a potential for improper installation of the devices.

**4.5.4.4.1** New devices introduced after January 1, 2008, shall comply with this requirement.

**4.5.4.5\*** The normal manual controls for actuation shall be located for easy accessibility at all times, including the time of fire.

**4.5.4.5.1** The manual control(s) shall be of distinct appearance and clearly recognizable for the purpose intended.

**4.5.4.5.2** The manual control(s) shall cause the complete system to operate in its normal fashion.

**4.5.4.5.3** Operation of this manual control shall not cause the time delay to recycle. (See 4.5.6.2.2.)

**4.5.4.6\*** All valves controlling the release and distribution of carbon dioxide shall be provided with an emergency manual control.

**4.5.4.6.1** The emergency manual control shall not be required of slave high-pressure cylinders.

**4.5.4.6.2** The emergency means shall be easily accessible and located close to the valves controlled.

**4.5.4.6.3** These devices shall be clearly marked with a warning placard to indicate the concept in 4.5.4.6.2.

#### 4.5.4.7\* Cylinders.

**4.5.4.7.1** Where gas pressure from pilot cylinders fed through the system discharge manifold (i.e., using back pressure rather than a separate pilot line) is used to release remaining slave cylinders and the supply consists of fewer than three cylinders, at least one cylinder shall be used for such operation.

**4.5.4.7.2** Where gas pressure from pilot cylinders that is fed through the system discharge manifold (i.e., using back pressure rather than a separate pilot line) is used to release remaining slave cylinders, and where the supply consists of three or more cylinders, there shall be at least one pilot cylinder more than the minimum required to actuate the system.

**4.5.4.7.3** During the full discharge acceptance test, the extra pilot cylinder shall be arranged to operate as a slave cylinder.

**4.5.4.7.4\*** Automatic actuation controls shall be arranged as follows:

- (1) To require a sustained fire alarm initiation signal prior to activation of predischARGE alarms.
- (2) To require activation of any electrically operated predischARGE time delays and electrically operated predischARGE alarms prior to activation of releasing devices.

#### 4.5.4.8 Manual Controls.

**4.5.4.8.1** Manual controls shall not require a pull of more than 40 lbf (178 N) nor a movement of more than 14 in. (356 mm) to secure operation.

**4.5.4.8.2** At least one manual control for actuation shall be positioned not more than 4 ft (1.2 m) above the floor.

**4.5.4.9** Where the continuing operation of equipment associated with a hazard being protected could contribute to sustaining the fire in that hazard, the source of power or fuel shall be automatically shut off.

**4.5.4.9.1** All shutdown devices shall be considered integral parts of the system and shall function with the system operation.

**4.5.4.9.2** The requirement in 4.5.4.9 shall not apply to lubricating oil systems associated with large rotating equipment, where an extended discharge system is provided that is designed to operate for the deceleration/cool-down period.

**4.5.4.10** All manual operating devices shall be identified as to the hazard they protect, the function they perform, and their method of operation.



**4.5.4.11** Abort switches shall not be used on carbon dioxide systems.

**4.5.4.12** For electrically operated systems, a service disconnect switch shall be provided to allow the system to be tested without actuating the fire suppression system. The service disconnect switch, when operated, shall interrupt the releasing circuit to the suppression system and shall cause a supervisory signal at the suppression system releasing panel.

**4.5.4.13 Discharge Pressure Switch.**

**4.5.4.13.1** A discharge pressure switch shall be installed between the carbon dioxide supply and the lockout valve.

**4.5.4.13.2** For low-pressure CO<sub>2</sub> systems where the manual, supervised, main shutoff valve can be considered a lockout valve (i.e., meets the requirements of 4.3.3.4 through 4.3.3.4.5), the pressure switch shall be located downstream of the automatic valve (master-selector, selector valve) supplying the hazard or hazards.

**4.5.4.13.3** The discharge pressure switch shall provide an alarm-initiating signal to the releasing panel to operate electric/electronic alarm appliances.

**4.5.5 Supervision and Lockout Valves.**

**4.5.5.1** Supervision of automatic systems and manual lockout valves shall be provided unless specifically waived by the authority having jurisdiction.

**4.5.5.2** Supervision of automatic systems shall be provided, and the lockout required by 4.3.3.4 shall be supervised for both automatic and manual systems unless specifically waived by the authority having jurisdiction.

**4.5.5.3\*** Interconnections between the components that are necessary for the control of the system and life safety shall be supervised.

**N 4.5.5.4** Normally unpressurized interconnections of pipe and tube shall not be required to comply with 4.5.5.3.

**4.5.5.5** An open circuit, ground-fault condition, or loss of integrity in the pneumatic control lines that would impair full system operation shall result in a trouble signal.

**4.5.5.6** The alarm and trouble signals shall be transmitted by one of the methods described in *NFPA 72*.

**4.5.5.7** High-pressure pneumatic-operated slave cylinder connections immediately adjacent to pilot cylinders shall not be required to be supervised.

**4.5.5.8** Where manual bypasses are provided and such bypasses are capable of being left in an open position, these bypasses shall be supervised.

**4.5.6\* Alarms.** Audible and visible warning alarms shall be provided for the following purposes:

- (1) To alert personnel not to enter a space, because the atmosphere in the space could be hazardous due to the presence of a high concentration of carbon dioxide
- (2) To provide personnel the opportunity to evacuate spaces that could be made unsafe by the discharge of a carbon dioxide system

**4.5.6.1** Audible and visual carbon dioxide system alarms shall be distinct from all other alarms, including the building fire alarm system.

**4.5.6.2 Predischarge Alarm and Time Delay.** A pneumatic predischarge alarm and pneumatic time delay and visible predischarge alarm shall be provided for the following enclosures:

- (1) Normally occupied and occupiable enclosures protected by total flooding systems except as outlined in 4.5.6.2.3
- (2) Local application systems protecting hazards where the discharge exposes personnel to concentrations of carbon dioxide in excess of 7.5 percent by volume of agent in air for longer than 5 minutes

**4.5.6.2.1** The predischarge alarms, where required, shall be located within the enclosure.

**4.5.6.2.2** The predischarge time delay shall provide a time delay for purpose of predischarge alarm of sufficient duration to allow evacuation of personnel from areas within the spaces most remote from the exits.

**4.5.6.2.3\*** Time delays shall be permitted to be eliminated for occupiable hazard areas where the provision of a time delay would result in unacceptable risk to personnel or unacceptable damage to critical pieces of equipment.

**4.5.6.2.4** Where time delays are omitted, provision shall be made to ensure that the carbon dioxide system is locked out any time personnel are present in the protected area or space.

**4.5.6.2.5** Dry runs shall be made to determine the minimum time needed for persons to evacuate the hazard area, allowing time to identify the warning signal.

**4.5.6.2.6** Audible signal appliances shall have either sound levels in accordance with 4.5.6.2.6.1 and 4.5.6.2.6.2 or acoustic characteristics in accordance with 18.4.6 of *NFPA 72*.

**4.5.6.2.6.1** Audible predischarge alarms shall be at least 15 dB above ambient noise level or 5 dB above maximum sound level, whichever is greater, measured 5 ft (1.5 m) above the floor of the occupiable area.

**4.5.6.2.6.2** Audible signal appliances shall have a sound level not more than 120 dB at the minimum hearing distance from the audible appliance.

**4.5.6.2.6.3** The predischarge alarm shall have a minimum decibel rating of 90 dBA at 10 ft (3 m).

**4.5.6.3** Visible and audible alarms shall be located outside each entrance to the following:

- (1) Normally occupied and occupiable space protected by a total flooding carbon dioxide system
- (2) Normally occupied and occupiable enclosures where the discharge from a local application system will expose personnel to hazardous concentrations of carbon dioxide
- (3) Normally occupied and occupiable spaces where carbon dioxide could migrate, creating a hazard to personnel

**4.5.6.3.1** These alarms shall begin operation prior to or at the start of the discharge.

**4.5.6.3.2\*** These alarms shall continue to operate after agent discharge until one of the following occurs:

- (1) Other positive action has been taken to prevent entry of personnel to the space containing an atmosphere made unsafe by the carbon dioxide discharge.
- (2) The space is ventilated and the safety of the atmosphere for entry by unprotected persons has been verified.

**4.5.6.3.3** Silencing of audible alarms while keeping visual notification appliances activated shall be permitted after the action described in 4.5.6.3.2(1) is accomplished.

**4.5.6.3.4** Visual alarms shall remain activated until the space is ventilated as required in 4.5.6.3.2(2).

**4.5.6.4** An alarm or indicator shall be provided to show that the system has operated and needs recharging.

**4.5.6.5\*** An alarm shall be provided to indicate the operation of automatic systems and that immediate personnel response is desired.

**4.5.6.6** Alarms indicating failure of supervised devices or equipment shall give prompt and positive indication of any failure and shall be distinctive from alarms indicating operation or hazardous conditions.

#### **4.5.7 Power Sources.**

**4.5.7.1** The primary source of energy for the operation and control of the system shall have the capacity for intended service and shall be reliable.

**4.5.7.1.1** Where failure of the primary source of energy will jeopardize protection provided for the hazard or for life safety, or for both, an independent secondary (standby) power supply shall supply energy to the system in the event of total failure or low voltage (less than 85 percent of the nameplate voltages) of the primary (main) power supply.

**4.5.7.1.2** The secondary (standby) supply shall be capable of operating the system under maximum normal load for 24 hours and then be capable of operating the system continuously for the full design discharge period.

**4.5.7.1.3** The secondary (standby) power supply shall automatically transfer to operate the system within 30 seconds of the loss of the primary (main) power supply.

**4.5.7.2** All electrical devices shall be operable between 85 percent and 105 percent of rated voltage.

#### **4.6 Carbon Dioxide Supply.**

**4.6.1\* Quantities.** The amount of the main supply of carbon dioxide in the system shall be at least sufficient for the largest single hazard protected or group of hazards that are to be protected simultaneously.

**4.6.1.1** Where hand hose lines are provided for use on a hazard protected by a fixed system, separate supplies shall be provided unless sufficient carbon dioxide is provided to ensure that the fixed protection for the largest single hazard on which the hose lines can be used will not be jeopardized. (See Section 7.4 and A.7.1.1.)

**4.6.1.2** Where the authority having jurisdiction determines that continuous protection is required, the quantity of reserve supply shall be as many multiples of the quantities required in 4.6.1 and 4.6.1.1 as the authority having jurisdiction considers necessary.

**4.6.1.3** Both main and reserve supplies for fixed storage systems shall be permanently connected to the piping and arranged for easy changeover, except where the authority having jurisdiction permits an unconnected reserve.

**4.6.2 Replenishment.** The time needed to obtain carbon dioxide for replenishment to restore systems to operating

condition shall be considered as a major factor in determining the reserve supply needed.

**4.6.3\* Quality.** Carbon dioxide shall have the following minimum properties:

- (1) The vapor phase shall be not less than 99.5 percent carbon dioxide with no detectable off-taste or odor.
- (2) The water content of the liquid phase shall comply with CGA G-6.2.
- (3) Oil content shall be not more than 10 ppm by weight.

#### **4.6.4 Storage Containers.**

**4.6.4.1** Storage containers and accessories shall be so located and arranged to facilitate inspection, maintenance, and recharging.

**4.6.4.2** Interruption to protection shall be held to a minimum.

**4.6.4.3** Storage containers shall be located as near as possible to the hazard or hazards they protect, but they shall not be located where they will be exposed to a fire or explosion in these hazards.

**4.6.4.4** Storage containers shall not be located where they will be subject to severe weather conditions or to mechanical, chemical, or other damage.

**4.6.4.5** Where excessive climatic or mechanical exposures are expected, guards or enclosures shall be provided.

**4.6.5\* High-Pressure Cylinders.** The carbon dioxide supply shall be stored in rechargeable cylinders designed to hold carbon dioxide in liquid form at ambient temperatures.

**4.6.5.1** The containers used in these systems shall be designed to meet the requirements of the U.S. Department of Transportation, the Canadian Transport Commission, or the equivalent governing agency.

**4.6.5.2\*** High-pressure cylinders used in fire-extinguishing systems shall not be recharged without a hydrostatic test (and remarking) if more than 5 years have elapsed from the date of the last test.

**4.6.5.2.1** Cylinders continuously in service without discharging shall be permitted to be retained in service for a maximum of 12 years from the date of the last hydrostatic test.

**4.6.5.2.2** At the end of 12 years, cylinders continuously in service without discharging shall be discharged and retested before being returned to service.

#### **4.6.5.3 Pressure Relief Device.**

**4.6.5.3.1** Each cylinder shall be provided with a pressure relief device of the rupture disk type.

**4.6.5.3.2** The pressure relief device shall be sized and fitted in accordance with the requirements specified in Department of Transportation (DOT) regulations 49 CFR 171–190.

#### **4.6.5.4 Manifolder Cylinders.**

**4.6.5.4.1** When manifolded, cylinders shall be mounted and supported in a rack provided for the purpose, including facilities for convenient individual servicing and content weighing.

**4.6.5.4.2** Automatic means shall be provided to prevent the loss of carbon dioxide from the manifold if the system is operated when any cylinder is removed for maintenance.

**4.6.5.4.3** In a multiple-cylinder system, all cylinders supplying the same manifold outlet for distribution of agent shall be interchangeable and of one select size.

**4.6.5.5** The ambient storage temperatures for local application systems shall not exceed 120°F (49°C) nor be less than 32°F (0°C).

**4.6.5.5.1** For total flooding systems, the ambient storage temperatures shall not exceed 130°F (54°C) nor be less than 0°F (-18°C) unless the system is designed for operation with storage temperatures outside of this range.

**4.6.5.5.2** External heating or cooling shall be permitted to be used to keep the temperature within the range given in 4.6.5.5.1.

**4.6.5.5.3** Where special cylinder charges are used to compensate for storage temperatures outside the ranges stated in 4.6.5.5 and 4.6.5.5.1, the cylinders shall be marked in a permanent manner.

**4.6.6\* Low-Pressure Storage Containers.** Low-pressure storage containers shall be designed to maintain the carbon dioxide supply at a nominal pressure of 300 psi (2068 kPa) corresponding to a temperature of approximately 0°F (-18°C).

#### **4.6.6.1 Container Requirements.**

**4.6.6.1.1** The pressure container shall be made, tested, approved, equipped, and marked in accordance with the current specifications of API-ASME *Code for Unfired Pressure Vessels for Petroleum Liquids and Gases*, or, in the case of mobile supply containers, if applicable, the requirements of DOT 49 CFR 171-190, or both.

**4.6.6.1.2** The design pressure shall be at least 325 psi (2241 kPa).

**4.6.6.2\*** In addition to the ASME and DOT code requirements referenced in 4.6.6.1.1, each pressure container shall be equipped with a liquid level gauge, a pressure gauge, and a high/low-pressure supervisory alarm set to alarm at no more than 90 percent of the pressure vessel's design maximum allowable working pressure (MAWP) and no less than 250 psi (1724 kPa).

**4.6.6.3** The pressure container shall be insulated and equipped with automatically controlled refrigeration or heating, or both, if necessary.

**4.6.6.4** The refrigeration system shall be capable of maintaining 300 psi (2068 kPa) in the pressure container under the highest expected ambient temperature.

#### **4.6.6.5 Heating.**

**4.6.6.5.1** The heating system, where required, shall be capable of maintaining 0°F (-18°C) in the pressure container under the lowest expected ambient temperature.

**4.6.6.5.2** Heating shall not be required to be provided unless known meteorological data indicate the likely occurrence of ambient temperatures that will cool the contents of the tank to reduce the pressure below 250 psi (1724 kPa) [approximately -10°F (-23°C)].

#### **4.7\* Distribution Systems.**

**4.7.1\*** Piping shall be of metallic noncombustible material having physical and chemical characteristics such that its deterioration under stress can be predicted with reliability.

**4.7.1.1** Where piping is installed in severely corrosive atmospheres, special corrosion-resistant materials or coatings shall be used.

**4.7.1.2** Materials for piping and the standards covering these materials shall be as described in 4.7.1.2.1 through 4.7.1.2.5.

**4.7.1.2.1** Black or galvanized steel pipe shall be either ASTM A53 seamless or electric welded, Grade A or B; or ASTM A106, Grade A, B, or C.

**4.7.1.2.1.1** ASTM A120 and ordinary cast-iron pipe shall not be used.

**4.7.1.2.1.2** Stainless steel shall be TP304 or TP316 for threaded connections or TP304, TP316, TP304L, or TP316L for welded connections.

**4.7.1.2.2** In systems using high-pressure supply, ¾ in. (20 mm) and smaller pipe shall be permitted to be Schedule 40.

**4.7.1.2.2.1** Pipe that is 1 in. (25 mm) through 4 in. (100 mm) shall be a minimum of Schedule 80.

**4.7.1.2.2.2** Furnace butt-weld ASTM A53 pipe shall not be used.

**4.7.1.2.3** In systems using low-pressure supply, pipe shall be a minimum of Schedule 40.

**4.7.1.2.3.1** Furnace butt-weld ASTM A53 pipe shall be permitted to be used.

**4.7.1.2.4** A dirt trap consisting of a tee with a capped nipple, at least 2 in. (51 mm) long, shall be installed at the end of each pipe run.

**4.7.1.2.5** Piping sections not normally opened to atmosphere shall not be required to have corrosion-resistant finish on the inside.

**4.7.1.3\*** Flexible piping system components not specifically covered in this standard shall have a minimum burst pressure of 5000 psi (34,474 kPa) for high-pressure systems or 1800 psi (12,411 kPa) for low-pressure systems.

**4.7.1.4** Class 150 and cast-iron fittings shall not be used.

**4.7.1.5** Fittings for high- and low-pressure systems shall be as described in 4.7.1.5.1 and 4.7.1.5.2.

#### **4.7.1.5.1 High-Pressure Systems.**

**4.7.1.5.1.1** Class 300 malleable iron fittings shall be used through 2 in. nominal pipe size (NPS) and forged steel fittings in all larger sizes.

**4.7.1.5.1.2** Flanged joints upstream of any stop valves shall be Class 600.

**Δ 4.7.1.5.1.3** Flanged joints downstream of stop valves or in systems with no stop valves shall be permitted to be Class 300.

**■ 4.7.1.5.1.4** Threaded unions shall, as a minimum, be equivalent to Class 2000 forged steel.

**4.7.1.5.1.5** Stainless steel fittings shall be Type 304 or 316, wrought or forged in accordance with ASTM A182, threaded or socket weld, for all sizes, 1/8 in. (3 mm) through 4 in. (100 mm).

**4.7.1.5.2 Low-Pressure Systems.**

**4.7.1.5.2.1** Class 300 malleable or ductile iron fittings shall be used through 3 in. (80 mm) nominal pipe size (NPS) and forged steel fittings in all larger sizes.

**4.7.1.5.2.2** Flanged joints shall be Class 300.

**4.7.1.5.2.3** Stainless steel fittings shall be Type 304 or 316 for threaded connections or Type 304, 316, 304L, or 316L for welded connections, wrought or forged in accordance with ASTM A182, Class 2000, threaded or socket weld, for all sizes, 1/8 in. (3 mm) through 4 in. (100 mm).

**4.7.1.6** Welded joints and screwed or flanged fittings (malleable iron or ductile iron) shall be permitted to be used.

**4.7.1.6.1** Mechanical grooved couplings and fittings shall be permitted to be used if they are specifically listed for carbon dioxide service.

**4.7.1.6.2** Flush bushings shall not be used.

**4.7.1.6.3** Where hex bushings are used for one pipe size reduction, a **Class 3000** steel bushing shall be provided to maintain adequate strength.

**4.7.1.6.4** Where hex bushings are used for more than one pipe size reduction, 4.7.1.5 shall be followed.

**4.7.1.6.5** Flared, compression-type, or brazed fittings shall be used with compatible tubing.

**4.7.1.6.6** Where brazed joints are used, the brazing alloy shall have a melting point of 1000°F (538°C) or higher.

**4.7.1.7 High-Pressure Supply.**

**4.7.1.7.1\*** In systems using high-pressure supply with pipe other than that specified in 4.7.1, the thickness of the pipe shall be calculated in accordance with ASME B31.1.

**4.7.1.7.2** The internal pressure for this calculation shall be 2800 psi (19,306 kPa).

**4.7.1.8 Low-Pressure Supply.**

**4.7.1.8.1\*** In systems using low-pressure supply with pipe other than that specified in 4.7.1, the thickness of the pipe shall be calculated in accordance with ASME B31.1.

**4.7.1.8.2** The internal pressure for this calculation shall be 450 psi (3103 kPa).

**Δ 4.7.2** The piping system shall not be subject to damage.

**4.7.2.1** Pipe shall be reamed and cleaned before assembly, and after assembly the entire piping system shall be blown out before nozzles or discharge devices are installed.

**4.7.2.2** In systems where valve arrangement introduces sections of closed piping, such sections shall be equipped with pressure relief devices, or the valves shall be designed to prevent entrapment of liquid carbon dioxide.

**4.7.2.2.1** For high-pressure systems, the pressure relief devices shall operate at a pressure no less than 2400 psi (16,547 kPa) and no more than 3000 psi (20,684 kPa).

**4.7.2.2.2** For low-pressure systems, the pressure relief devices shall operate at a pressure no higher than 450 psi (3103 kPa).

**4.7.2.2.3** Where pressure-operated cylinder valves are used, a means shall be provided to vent any cylinder gas leakage from the manifold, but the means shall also prevent loss of gas when the system operates.

**4.7.2.3** All pressure relief devices shall be of such design and so located that the discharge of carbon dioxide therefrom will not injure personnel.

**4.7.3 Valves.**

**4.7.3.1** All valves shall be suitable for the intended use, particularly regarding flow capacity and operation.

**4.7.3.2** All valves shall be used only under temperatures and other conditions for which they are listed or approved.

**4.7.3.3** Valves used in systems with high-pressure storage and constantly under pressure shall have a minimum bursting pressure of 6000 psi (41,369 kPa), whereas those not under constant pressure shall have a minimum bursting pressure of at least 5000 psi (34,474 kPa).

**4.7.3.4** Valves used in systems using low-pressure storage shall withstand a hydrostatic test to 1800 psi (12,411 kPa) without permanent distortion.

**4.7.3.5** For flanged valves, the class and style of flanges required to match the valve's flanged connection shall be used.

**4.7.3.6** Valves shall be located, installed, or suitably protected so that they are not subject to mechanical, chemical, or other damage that would render them inoperative.

**4.7.3.7** Valves shall be rated for equivalent length in terms of the pipe or tubing sizes with which they will be used.

**4.7.3.8** The equivalent length of cylinder valves shall include siphon tube, valve, discharge head, and flexible connector.

**4.7.4\* Discharge Nozzles.** Discharge nozzles shall be for the use intended and shall be listed or approved for discharge characteristics.

**4.7.4.1** Discharge nozzles shall be of proper strength for use with the expected working pressures, shall be able to resist nominal mechanical abuse, and shall be constructed to withstand expected temperatures without deformation.

**4.7.4.2** Discharge orifices shall be of corrosion-resistant metal.

**4.7.4.3** Discharge nozzles used in local application systems shall be connected and supported so that they cannot readily be put out of adjustment.

**4.7.4.4\*** Discharge nozzles shall be permanently marked to identify the nozzle and to show the equivalent single-orifice diameter regardless of shape and number of orifices.

**4.7.4.4.1** This equivalent diameter shall refer to the orifice diameter of the standard single-orifice-type nozzle having the same flow rate as the nozzle in question.

**4.7.4.4.2** The marking shall be readily discernible after **in-**stallation.

**4.7.4.4.3\*** The standard orifice shall be an orifice having a rounded entry with a coefficient of discharge not less than 0.98



and with the flow characteristics as given in Table 4.7.5.2.1 and Table 4.7.5.3.1.

**4.7.4.4.4 Orifice sizes other than those shown in Table A.4.7.4.4.3 shall be permitted to be used and shall be permitted to be marked as decimal orifice equipment.**

**4.7.4.5 Discharge Devices.**

**4.7.4.5.1** Discharge nozzles shall be provided with frangible disks or blowout caps where clogging by foreign materials is likely.

**4.7.4.5.2** These devices shall provide an unobstructed opening upon system operation.

**4.7.5 Pipe and Orifice Size Determination.** Pipe sizes and orifice areas shall be selected on the basis of calculations to deliver the required rate of flow at each nozzle.

**4.7.5.1\*** The following equation or curves developed therefrom shall be used to determine the pressure drop in the pipeline:

[4.7.5.1]

$$Q^2 = \frac{(3647)(D^{5.25}Y)}{L + 8.08(D^{1.25}Z)}$$

where:

- Q = flow rate [lb/min (kg/min)]
- D = actual inside pipe diameter [in. (mm)]
- L = equivalent length of pipeline [ft (m)]

Y and Z = factors depending on storage and line pressure

**4.7.5.2** For systems with low-pressure storage, flow shall be calculated on the basis of an average storage pressure of 300 psi (2068 kPa) during discharge.

**4.7.5.2.1** The discharge rate for equivalent orifices shall be based on the values given in Table 4.7.5.2.1.

**4.7.5.2.2** Design nozzle pressures shall not be less than 150 psi (1034 kPa).

**4.7.5.3** For systems with high-pressure storage, flow shall be calculated on the basis of an average storage pressure of 750 psi (5171 kPa) during discharge for normal 70°F (21°C) storage.

**4.7.5.3.1** The discharge rate through equivalent orifices shall be based on the values given in Table 4.7.5.3.1.

**4.7.5.3.2** Design nozzle pressure at 70°F (21°C) storage shall be greater than or equal to 300 psi (2068 kPa).

**N 4.7.6\* Pipe Hangers and Supports.** Pipe hangers and supports shall be designed and installed in accordance with recognized industry practices and manufacturer’s instructions.

**N 4.7.6.1** All pipe hangers and supports shall be attached directly to a rigid, fixed structure.

**N 4.7.6.2** All hangers and components shall be steel.

**N 4.7.6.3** Ordinary cast-iron hangers/supports, conduit clamps, or “C” clamps shall not be used.

**N 4.7.6.4** All pipe supports shall be designed and installed to prevent lateral movement of supported pipe during system discharge while permitting longitudinal movement to accommodate expansion and contraction caused by temperature changes.

**N 4.7.6.4.1** Rigid hangers shall be installed wherever a change in elevation or direction occurs.

**N 4.7.6.4.2** Nozzles shall be supported so as to prevent movement of the nozzle during discharge.

**N 4.7.6.5** Where seismic bracing is required, bracing shall be in accordance with local codes and the authority having jurisdiction.

**Table 4.7.5.2.1 Discharge Rate per Square Inch of Equivalent Orifice Area for Low-Pressure Storage [300 psi (2068 kPa)]**

Orifice Pressure		Discharge Rate	
psi	kPa	lb/min-in. <sup>2</sup>	kg/min-mm <sup>2</sup>
300	2068	4220	2.970
290	1999	2900	2.041
280	1931	2375	1.671
270	1862	2050	1.443
260	1793	1825	1.284
250	1724	1655	1.165
240	1655	1525	1.073
230	1586	1410	0.992
220	1517	1305	0.918
210	1448	1210	0.851
200	1379	1125	0.792
190	1310	1048	0.737
180	1241	977	0.688
170	1172	912	0.642
160	1103	852	0.600
150	1034	795	0.559

**Table 4.7.5.3.1 Discharge Rate per Square Inch of Equivalent Orifice Area for High-Pressure Storage [750 psi (5171 kPa)]**

Orifice Pressure		Discharge Rate	
psi	kPa	lb/min-in. <sup>2</sup>	kg/min-mm <sup>2</sup>
750	5171	4630	3.258
725	4999	3845	2.706
700	4826	3415	2.403
675	4654	3090	2.174
650	4481	2835	1.995
625	4309	2615	1.840
600	4137	2425	1.706
575	3964	2260	1.590
550	3792	2115	1.488
525	3620	1985	1.397
500	3447	1860	1.309
475	3275	1740	1.224
450	3103	1620	1.140
425	2930	1510	1.063
400	2758	1400	0.985
375	2586	1290	0.908
350	2413	1180	0.830
325	2241	1080	0.760
300	2068	980	0.690

#### 4.8\* Inspection, Maintenance, and Instruction.

**4.8.1\* Inspection.** At least every 30 days, an inspection shall be conducted to assess the system's operational condition.

#### 4.8.2 Hose Testing.

**4.8.2.1** All system hose, including those used as flexible connectors, shall be tested at 2500 psi (17,239 kPa) for high-pressure systems and at 900 psi (6205 kPa) for low-pressure systems.

**4.8.2.2** Hose shall be tested as follows:

- (1) The hose shall be removed from any attachment.
- (2) Hose for hand lines shall be checked for electrical continuity between couplings.
- (3) The hose assembly shall then be placed in a protective enclosure designed to permit visible observation of the test.
- (4) The hose shall be completely filled with water before testing.
- (5) Pressure shall then be applied at a rate-of-pressure rise to reach the test pressure within 1 minute.
- (6) The test pressure shall be maintained for 1 full minute.
- (7) Observations shall then be made to note any distortion or leakage.
- (8) If the test pressure has not dropped and if the couplings have not moved, the pressure shall be released.
- (9) The hose assembly shall be considered to have passed the hydrostatic test if no permanent distortion has taken place.
- (10) Hose assembly passing the test shall be completely dried internally.
- (11) If heat is used for drying, the temperature shall not exceed 150°F (66°C).
- (12) Hose assemblies failing this test shall be marked, destroyed, and replaced with new assemblies.
- (13) Hose assemblies passing this test shall be marked with the date of the test on the hose.

**4.8.2.3** All system hose, including those used as flexible connectors, shall be tested every 5 years in accordance with 4.8.2.

#### 4.8.3\* Maintenance.

**4.8.3.1 Test and Maintenance Procedures.** A manufacturer's test and maintenance procedure shall be provided to the owner for testing and maintenance of the system. This procedure shall provide for the initial testing of the equipment as well as for periodic test inspection and maintenance of the system. Actuation, impairment, and restoration of this protection shall be reported promptly to the authority having jurisdiction.

**4.8.3.2** The following shall be verified by competent personnel at least annually using available documentation required in 4.4.2.14:

- (1) Check and test the carbon dioxide system for operation.
- (2) Check that there have been no changes to the size, type, and configuration of the hazard and system.
- (3) Check and test all time delays for operation.
- (4) Check and test all audible alarms for operation.
- (5) Check and test all visible signals for operation.
- (6) Check that all warning signs are installed in accordance with 4.3.2.

- (7) Check to ensure that the procedures in 4.5.6 are appropriate and the devices in 4.5.6 are operable.
- (8) Check and test each detector using methods specified in *NFPA 72*.

**4.8.3.2.1** The goal of this maintenance and testing shall be not only to ensure that the system is in full operating condition, but shall also indicate the probable continuance of that condition until the next inspection.

**4.8.3.2.2** Discharge tests shall be made when any maintenance indicates their advisability.

**4.8.3.2.3** Prior to testing, safety procedures shall be reviewed. (See Section 4.3 and A.4.3.)

**4.8.3.3\*** A maintenance report with recommendations shall be filed with the owner.

**4.8.3.4\*** Any penetrations made through the enclosure protected by the carbon dioxide total flooding system shall be sealed immediately. The method of sealing shall restore the original fire resistance rating of the enclosure.

#### 4.8.3.5 High-Pressure Cylinder Weights.

**4.8.3.5.1** At least semiannually, all high-pressure cylinders shall be weighed, and the date of the last hydrostatic test noted. (See 4.6.5.2.)

**4.8.3.5.2** If, at any time, a container shows a loss in net content of more than 10 percent, it shall be refilled or replaced.

#### 4.8.3.6 Low-Pressure Container Liquid Levels.

**4.8.3.6.1** At least weekly, the liquid level gauges of low-pressure containers shall be observed.

**4.8.3.6.2** If at any time a container shows a loss of more than 10 percent, it shall be refilled, unless the minimum gas requirements are still provided.

**4.8.4\* Instruction.** Persons who inspect, test, maintain, or operate carbon dioxide fire-extinguishing systems shall be thoroughly trained in the functions they perform.

## Chapter 5 Total Flooding Systems

**5.1 General Information.** See also Annex D.

**5.1.1 Description.** A total flooding system shall consist of a fixed supply of carbon dioxide permanently connected to fixed piping, with fixed nozzles arranged to discharge carbon dioxide into an enclosed space or enclosure about the hazard.

**5.1.2\* Uses.** A total flooding system shall be used where there is a permanent enclosure around the hazard that enables the required concentration of carbon dioxide to be built up and to be maintained for the required period of time.

**5.1.3 General Requirements.** Total flooding systems shall be designed, installed, tested, and maintained in accordance with the applicable requirements in Chapter 4 and with the additional requirements set forth in this chapter.

**5.1.4 Safety Requirements.** See Section 4.3 and 4.5.6.

## 5.2 Hazard Specifications.

### 5.2.1\* Enclosure.

**5.2.1.1\*** For flash- or surface-type fires, such as will be present with flammable liquids, any unclosable openings shall be compensated for by additional carbon dioxide as specified in 5.3.5.1.

**5.2.1.2** If the quantity of carbon dioxide required for compensation exceeds the basic quantities required for flooding without leakage, the system shall be permitted to be designed for local application in accordance with Chapter 6.

**5.2.1.3\*** For deep-seated fires, such as will be involved with solids, unclosable openings shall be restricted to those bordering or actually in the ceiling where the size of the openings exceeds the pressure relief venting requirements set forth in 5.6.2.

**5.2.1.4** To prevent fire from spreading through openings to adjacent hazards or work areas that can be possible re-ignition sources, such openings shall be provided with automatic closures or local application nozzles.

**5.2.1.4.1** The gas required for such protection shall be in addition to the normal requirement for total flooding. (See 6.4.3.6.)

**5.2.1.4.2** Where neither method in 5.2.1.4 or 5.2.1.4.1 is practical, protection shall be extended to include these adjacent hazards or work areas.

**5.2.1.5** In the case of process and storage tanks where safe venting of flammable vapors and gases cannot be realized, the use of external local application systems outlined in 6.4.3.6 shall be required.

**5.2.2 Leakage and Ventilation.** Because the efficiency of carbon dioxide systems depends on the maintenance of an extinguishing concentration of carbon dioxide, leakage of gas from the space shall be kept to a minimum and compensated for by applying extra gas.

**5.2.2.1** Where possible, openings such as doorways, windows, and so forth, shall be arranged to close automatically before, or simultaneously with, the start of the carbon dioxide discharge, or 5.3.5.1 and 5.4.4.1 shall be followed. (For personnel safety, see Section 4.3.)

**5.2.2.2** Where forced-air ventilating systems are involved, they preferably shall be shut down or closed, or both, before, or simultaneously with, the start of the carbon dioxide discharge, or additional compensating gas shall be provided. (See 5.3.5.2.)

**5.2.3\* Types of Fires.** Fires that can be extinguished by total flooding methods shall be divided into the following two categories:

- (1) Surface fires involving flammable liquids, gases, and solids
- (2) Deep-seated fires involving solids subject to smoldering

**5.2.3.1\*** Carbon dioxide shall be quickly introduced into the enclosure in a quantity to overcome leakage and provide an extinguishing concentration for the particular materials involved for surface fires that are subject to prompt extinguishment.

**5.2.3.2\*** For deep-seated fires, the required extinguishing concentration shall be maintained for a period of time to allow the smoldering to be extinguished and the material to cool to a point at which re-ignition will not occur when the inert atmosphere is dissipated.

## 5.3 Carbon Dioxide Requirements for Surface Fires.

### 5.3.1 General.

**5.3.1.1** The quantity of carbon dioxide for surface-type fires shall be based on average conditions assuming fairly prompt extinguishment.

**5.3.1.2** Although a reasonable allowance for normal leakage is included in the basic volume factors, corrections shall be made for the type of material involved and any other special conditions.

### 5.3.2 Flammable Materials.

**5.3.2.1** Consideration shall be given to the determination of the design concentration of carbon dioxide required for the type of flammable material involved in the hazard.

**5.3.2.1.1** The design concentration shall be determined by adding a factor (20 percent) to the minimum effective concentration.

**5.3.2.1.2** In no case shall a concentration less than 34 percent be used.

**▲ 5.3.2.2\*** Table 5.3.2.2 shall be used to determine the minimum carbon dioxide concentrations for the liquids and gases shown in the table.

**5.3.2.3** For materials not given in Table 5.3.2.2, the minimum theoretical carbon dioxide concentration shall be obtained from some recognized source or determined by test.

**5.3.2.4** If maximum residual oxygen values are available, the theoretical carbon dioxide concentration shall be calculated by using the following formula:

[5.3.2.4]

$$\%CO_2 = \left( \frac{21 - O_2}{21} \right) (100)$$

**5.3.3 Volume Factor.** The volume factor used to determine the basic quantity of carbon dioxide to protect an enclosure containing a material requiring a design concentration of 34 percent shall be in accordance with Table 5.3.3(a) and Table 5.3.3(b).

**5.3.3.1\*** In figuring the net cubic capacity to be protected, due allowance shall be permitted to be made for permanent nonremovable, impermeable structures materially reducing the volume.

### 5.3.3.2 Interconnected Volumes.

**5.3.3.2.1** In two or more interconnected volumes where free flow of carbon dioxide can take place, the carbon dioxide quantity shall be the sum of the quantities calculated for each volume, using its respective volume factor from Table 5.3.3(a) or Table 5.3.3(b).



△ **Table 5.3.2.2 Minimum Carbon Dioxide Concentrations for Extinguishment**

Material	Theoretical Minimum CO <sub>2</sub> Concentration (%)	Minimum Design CO <sub>2</sub> Concentration (%)
Acetylene	55	66
Acetone	27*	34
Aviation gas grades 115/145	30	36
Benzol, benzene	31	37
Butadiene	34	41
Butane	28	34
Butane-I	31	37
Carbon disulfide	60	72
Carbon monoxide	53	64
Coal or natural gas	31*	37
Cyclopropane	31	37
Diethyl ether	33	40
Dimethyl ether	33	40
Dowtherm	38*	46
Ethane	33	40
Ethyl alcohol	36	43
Ethyl ether	38*	46
Ethylene	41	49
Ethylene dichloride	21	34
Ethylene oxide	44	53
Gasoline	28	34
Higher paraffin hydrocarbons C <sub>n</sub> H <sub>2n+2</sub> , n≥5	28	34
Hydrogen	62	75
Hydrogen sulfide	30	36
Isobutane	30*	36
Isobutylene	26	34
Isobutyl formate	26	34
JP-4	30	36
Kerosene	28	34
Methane	25	34
Methyl acetate	29	35
Methyl alcohol	33	40
Methyl butene-I	30	36
Methyl ethyl ketone	33	40
Methyl formate	32	39
Pentane	29	35
Propane	30	36
Propylene	30	36
Quench, lube oils	28	34

Note: The theoretical minimum extinguishing concentrations in air for the materials in the table were obtained from a compilation of Bureau of Mines, Bulletins 503 and 627.

\*Calculated from accepted residual oxygen values.

5.3.3.2.2 If one volume requires greater than normal concentration (see 5.3.4), the higher concentration shall be used in all interconnected volumes.

5.3.4 **Material Conversion Factor.** For materials requiring a design concentration over 34 percent, the basic quantity of carbon dioxide calculated from the volume factor given in Table 5.3.3(a) and Table 5.3.3(b) shall be increased by multiplying this quantity by the appropriate conversion factor given in Figure 5.3.4.

**Table 5.3.3(a) Volume Factors and Flooding Factors**

(A) Volume of Space (ft <sup>3</sup> )	(B) Volume Factor (ft <sup>3</sup> /lb CO <sub>2</sub> )	(C) Flooding Factor (lb CO <sub>2</sub> /ft <sup>3</sup> )	(D) Calculated Quantity (lb) (Not Less Than)
Up to 140	14	0.072	—
141–500	15	0.067	10
501–1600	16	0.063	35
1601–4500	18	0.056	100
4501–50,000	20	0.050	250
Over 50,000	22	0.046	2500

△ **Table 5.3.3(b) Volume Factors and Flooding Factors (SI Units)**

(A) Volume of Space (m <sup>3</sup> )	(B) Volume Factor (m <sup>3</sup> /kg CO <sub>2</sub> )	(C) Flooding Factor (kg CO <sub>2</sub> /m <sup>3</sup> )	(D) Calculated Quantity (kg) (Not Less Than)
Up to 3.96	0.86	1.15	—
3.97–14.15	0.93	1.07	4.5
14.16–45.28	0.99	1.01	15.1
45.29–127.35	1.11	0.90	45.4
127.36–1415.0	1.25	0.80	113.5
Over 1415.0	1.37	0.74	1135.0

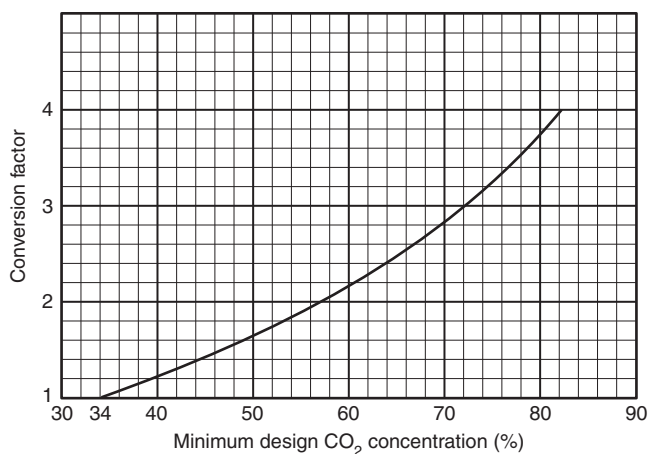

**FIGURE 5.3.4 Material Conversion Factors.**

**5.3.5 Special Conditions.** Additional quantities of carbon dioxide shall be provided to compensate for any special condition that could adversely affect the extinguishing efficiency.

**5.3.5.1\* Openings That Cannot Be Closed.**

**5.3.5.1.1** Any openings that cannot be closed at the time of extinguishment shall be compensated for by the addition of a quantity of carbon dioxide equal to the anticipated loss at the design concentration during a 1-minute period.

**5.3.5.1.2** This amount of carbon dioxide shall be applied through the regular distribution system. (See 5.2.1.1 and A.5.5.2.)

**5.3.5.2 Ventilating Systems.**

**5.3.5.2.1** For ventilating systems that cannot be shut down, additional carbon dioxide shall be added to the space through the regular distribution system in an amount computed by dividing the volume moved during the liquid discharge period by the flooding factor.

**5.3.5.2.2** This additional amount of carbon dioxide shall be multiplied by the material conversion factor (determined from Figure 5.3.4) when the design concentration is greater than 34 percent.

**5.3.5.3\*** For applications where the normal temperature of the enclosure is above 200°F (93°C), a 1 percent increase in the calculated total quantity of carbon dioxide shall be provided for each additional 5°F (2.8°C) above 200°F (93°C).

**5.3.5.4** For applications where the normal temperature of the enclosure is below 0°F (-18°C), a 1 percent increase in the calculated total quantity of carbon dioxide shall be provided for each degree Fahrenheit below 0°F (-18°C).

**5.3.5.5\*** Except for unusual conditions, it shall not be required to provide extra carbon dioxide to maintain the design concentration.

**5.3.5.6** If a hazard contains a liquid having an auto-ignition temperature below its boiling point, the carbon dioxide concentration shall be maintained for a sufficient period to allow the liquid temperature to cool below its auto-ignition temperature. (See 6.3.3.5.)

**5.3.5.7\* Flooding Factor.**

**5.3.5.7.1** A flooding factor of 8 ft<sup>3</sup>/lb (0.50 m<sup>3</sup>/kg) shall be used in ducts and covered trenches.

**5.3.5.7.2** If the combustibles represent a deep-seated fire, the fire shall be treated as described in Section 5.4.

**5.4 Carbon Dioxide Requirements for Deep-Seated Fires.**

**5.4.1\* General.**

**5.4.1.1** After the design concentration is reached, the concentration shall be maintained for a substantial period of time, but not less than 20 minutes.

**5.4.1.2** Any possible leakage shall be given special consideration because no allowance is included in the basic flooding factors.

**5.4.2\* Combustible Materials.**

△ **5.4.2.1\*** The design concentrations listed in Table 5.4.2.1 shall be achieved for the hazards listed.

**5.4.2.2 Other Deep-Seated Fires.**

**5.4.2.2.1** Flooding factors for other deep-seated fires shall be justified to the satisfaction of the authority having jurisdiction before use.

**5.4.2.2.2** Consideration shall be given to the mass of material to be protected because the thermal insulating effects reduce the rate of cooling.

**5.4.3 Volume Consideration.**

**5.4.3.1** The volume of the space shall be determined in accordance with 5.3.3.1.

**5.4.3.2** The basic quantity of carbon dioxide required to protect an enclosure shall be obtained by treating the volume of the enclosure by the flooding factor given in 5.4.2.

**5.4.4 Special Conditions.** Additional quantities of carbon dioxide shall be provided to compensate for any special condition that could adversely affect the extinguishing efficiency. (See 5.3.5.2, 5.3.5.3, and 5.3.5.4.)

**5.4.4.1** Any openings that cannot be closed at the time of extinguishment shall be compensated for by the addition of carbon dioxide equal in volume to the expected leakage volume during the extinguishing period.

**5.4.4.2** If leakage is appreciable, consideration shall be given to an extended discharge system as covered in 5.5.3. (See also 5.2.1.3.)

**5.5 Distribution System.**

**5.5.1 General.** The distribution system for applying carbon dioxide to enclosed hazards shall be designed with due consideration for the materials involved and the nature of the enclosure, because these items can require various discharge times and rates of application.

△ Table 5.4.2.1 Volume Factors and Flooding Factors for Specific Hazards

Design Concentration (%)	Volume Factors		Flooding Factors		Specific Hazards
	ft <sup>3</sup> /lb CO <sub>2</sub>	m <sup>3</sup> /kg CO <sub>2</sub>	lb CO <sub>2</sub> /ft <sup>3</sup>	kg CO <sub>2</sub> /m <sup>3</sup>	
50	10	0.62	0.100	1.60	Dry electrical hazards in general [spaces less than 2000 ft <sup>3</sup> (56.6 m <sup>3</sup> )]
50	12	0.75	0.083 (200 lb minimum)	1.33 (91 kg minimum)	Dry electrical hazards in general [spaces greater than 2000 ft <sup>3</sup> (56.6 m <sup>3</sup> )]
65	8	0.50	0.125	2.00	Record (bulk paper) storage, ducts, covered trenches
75	6	0.38	0.166	2.66	Fur storage vaults, dust collectors

**5.5.2\* Rate of Application.** The minimum design rate of application shall be based on the quantity of carbon dioxide and the maximum time to achieve design concentration.

**5.5.2.1\*** For surface fires, the design concentration shall be achieved within 1 minute from start of discharge.

**5.5.2.2** For high-pressure systems, if a part of the hazard is to be protected by total flooding, the discharge rate for the total flooding portion shall be computed as specified in 6.3.2.3.

**5.5.2.3** For deep-seated fires, the design concentration shall be achieved within 7 minutes, but the rate shall be not less than that required to develop a concentration of 30 percent in 2 minutes.

**5.5.3\* Enclosed Rotating Electrical Equipment.** For enclosed rotating electrical equipment, a minimum concentration of 30 percent shall be maintained for the deceleration period, but not less than 20 minutes.

#### 5.5.4 Piping Systems.

**5.5.4.1** Piping shall be designed in accordance with 4.7.5 to deliver the required rate of application at each nozzle.

**5.5.4.2\*** High-pressure storage temperatures shall be permitted to range from 0°F to 130°F (-18°C to 54°C) without requiring special methods of compensating for changing flow rates. (See 4.6.5.5.)

**5.5.5 Nozzle Sizing and Distribution.** Nozzles used in connection with total flooding systems with either high- or low-pressure supply shall be of a type suitable for the intended purpose and shall be located to achieve the best results.

#### 5.5.5.1 Nozzle Selection.

**5.5.5.1.1** The types of nozzles selected and their placement shall be such that the discharge will not unduly splash flammable liquids or create dust clouds that could extend the fire, create an explosion, or otherwise adversely affect the contents of the enclosure.

**5.5.5.1.2** Nozzles vary in design and discharge characteristics and shall be selected on the basis of their adequacy for the use intended.

**5.5.5.2** Spacing and sizing of nozzles in ductwork is dependent on many factors such as velocity in duct, location and effectiveness of dampers, possible loading of duct walls with combustible deposits, duct length, and cross-sectional dimensions.

**5.5.5.2.1** The nozzle locations and sizing shall be selected to ensure distribution of the carbon dioxide throughout the entire length of the ductwork.

**5.5.5.2.2** Automatic dampers shall be provided to close on system operation.

**5.5.5.2.3** No allowance shall be required for inlet and outlet duct openings that have surface hazards only. (See 5.3.5.7 and Table 5.4.2.1.)

#### 5.6 Venting Consideration.

**5.6.1\* General.** The venting of flammable vapors and pressure buildup from the discharge of quantities of carbon dioxide into closed spaces shall be considered. (See 5.2.1.5.)

**5.6.2\* Pressure Relief Venting.** For very tight enclosures, the necessary area of free venting shall be calculated from the following equation:

$$X = \frac{Q}{1.3\sqrt{P}}$$

[5.6.2]

where:

$X$  = free venting area (in.<sup>2</sup>)

$Q$  = calculated carbon dioxide flow rate (lb/min)

$P$  = allowable strength of enclosure (lb/ft<sup>2</sup>)

**5.6.2.1** Satisfactory results shall be achieved by assuming the expansion of carbon dioxide to be 9 ft<sup>3</sup>/lb (0.56 m<sup>3</sup>/kg).

**5.6.2.2** For SI units, the following equation shall apply:

$$X = \frac{239Q}{\sqrt{P}}$$

[5.6.2.2]

where:

$X$  = free venting area (mm<sup>2</sup>)

$Q$  = calculated carbon dioxide flow rate (kg/min)

$P$  = allowable strength of enclosure (kPa)

## Chapter 6 Local Application Systems

**6.1 General Information.** See also Annex F.

**6.1.1 Description.** A local application system shall consist of a fixed supply of carbon dioxide permanently connected to a system of fixed piping with nozzles arranged to discharge directly into the fire.

**6.1.2\* Uses.** Local application systems shall be used for the extinguishment of surface fires in flammable liquids, gases, and shallow solids, where the hazard is not enclosed or where the enclosure does not conform to the requirements for total flooding.

**6.1.3 General Requirements.** Local application systems shall be designed, installed, tested, and maintained in accordance with the applicable requirements in previous chapters and with the additional requirements set forth in this chapter.

**6.1.4\* Safety Requirements.**

#### 6.2 Hazard Specifications.

**6.2.1 Extent of Hazard.** The hazard shall be so isolated from other hazards or combustibles that fire will not spread outside the protected area.

**6.2.1.1** The entire hazard shall be protected.

**6.2.1.2** The hazard shall include all areas that are, or can become, coated by combustible liquids or shallow solid coatings, such as areas subject to spillage, leakage, dripping, splashing, or condensation.

**6.2.1.3** The hazard shall also include all associated materials or equipment, such as freshly coated stock, drain boards, hoods, ducts, and so forth, that could extend fire outside or lead fire into the protected area.

**6.2.1.4** A series of interexposed hazards shall be permitted to be subdivided into smaller groups or sections with the approval of the authority having jurisdiction.

**6.2.1.5** Systems for such hazards shall be designed to give immediate independent protection to adjacent groups or sections as needed.

## 6.2.2 Location of Hazard.

**6.2.2.1** The hazard shall be permitted to be indoors, partly sheltered, or completely outdoors.

**6.2.2.2** It is essential that the carbon dioxide discharge shall be such that winds or strong air currents do not impair the protection.

## 6.3 Carbon Dioxide Requirements.

**6.3.1\* General.** The quantity of carbon dioxide required for local application systems shall be based on the total rate of discharge needed to blanket the area or volume protected and the time that the discharge must be maintained to ensure complete extinguishment.

### 6.3.1.1\* High-Pressure Storage.

**6.3.1.1.1** For systems with high-pressure storage, the computed quantity of carbon dioxide shall be increased by 40 percent to determine nominal cylinder storage capacity because only the liquid portion of the discharge is effective.

**6.3.1.1.2** This increase in cylinder storage capacity shall not be required for the total flooding portion of combined local application–total flooding systems.

**6.3.1.2\*** The quantity of carbon dioxide in storage shall be increased by an amount to compensate for liquid vaporized in cooling the piping.

**6.3.2 Rate of Discharge.** Nozzle discharge rates shall be determined by either the surface method, as covered in Section 6.4, or the volume method, as covered in Section 6.5.

**6.3.2.1** The total rate of discharge for the system shall be the sum of the individual rates of all the nozzles or discharge devices used on the system.

**6.3.2.2** For low-pressure systems, if a part of the hazard is to be protected by total flooding, the discharge rate for the total flooding part shall develop the required concentration in not more than the discharge time used for the local application part of the system.

**6.3.2.3** For high-pressure systems, if a part of the hazard is to be protected by total flooding, the discharge rate for the total flooding part shall be computed by dividing the quantity required for total flooding by the factor 1.4 and by the time of the local application discharge in minutes, as shown in the following equation:

[6.3.2.3]

$$Q_F = \frac{W_F}{1.4T_L}$$

where:

$Q_F$  = rate of flow for the total flooding portion [lb/min (kg/min)]

$W_F$  = total quantity of carbon dioxide for the total flooding portion [lb (kg)]

$T_L$  = liquid discharge time for the local application portion (min)

### 6.3.3\* Duration of Discharge.

**6.3.3.1** The minimum liquid discharge time from all nozzles shall be 30 seconds.

**6.3.3.2\*** All local application nozzles protecting a single hazard shall concurrently discharge liquid for a period not less than the minimum liquid discharge time.

**6.3.3.3** The minimum time shall be increased to compensate for any hazard condition that would require a longer cooling period to ensure complete extinguishment.

**6.3.3.4** Where there is a possibility that metal or other material can become heated above the ignition temperature of the fuel, the effective discharge time shall be increased to allow adequate cooling time.

**6.3.3.5\*** Where the fuel has an auto-ignition point below its boiling point, such as paraffin wax and cooking oils, the effective discharge time shall be increased to permit cooling of the fuel to prevent re-ignition.

**6.3.3.5.1** The minimum liquid discharge time shall be 3 minutes.

## 6.4 Rate-by-Area Method.

**6.4.1\* General.** The area method of system design shall be used where the fire hazard consists primarily of flat surfaces or low-level objects associated with horizontal surfaces.

**6.4.1.1** System design shall be based on listing or approval data for individual nozzles.

**6.4.1.2** Extrapolation of such data above or below the upper or lower limits shall not be permitted.

**6.4.2 Nozzle Discharge Rates.** The design discharge rate through individual nozzles shall be determined on the basis of location or projection distance in accordance with specific approvals or listings.

**6.4.2.1\*** The discharge rate for overhead-type nozzles shall be determined solely on the basis of distance from the surface each nozzle protects.

**6.4.2.2\*** The discharge rate for tankside nozzles shall be determined solely on the basis of the throw or projection required to cover the surface each nozzle protects.

**6.4.3 Area per Nozzle.** The maximum area protected by each nozzle shall be determined on the basis of location or projection distance and the design discharge rate in accordance with specific approvals or listings.

**6.4.3.1** The same factors used to determine the design discharge rate shall be used to determine the maximum area to be protected by each nozzle.

**6.4.3.2** The portion of the hazard protected by individual overhead-type nozzles shall be considered as a square area.



**6.4.3.3** The portion of the hazard protected by individual tankside or linear nozzles is either a rectangular or square area in accordance with spacing and discharge limitations stated in specific approvals or listings.

**6.4.3.4\*** Where coated rollers or other similar irregular shapes are to be protected, the projected wetted area shall be used to determine nozzle coverage.

**6.4.3.5** Where coated surfaces are to be protected, the area per nozzle shall be permitted to be increased to a maximum of 40 percent over the areas given in specific approvals or listings.

**6.4.3.5.1** Coated surfaces shall be defined as those designed for drainage that are constructed and maintained so that no pools of liquid will accumulate over a total area exceeding 10 percent of the protected surface.

**6.4.3.5.2** Paragraph 6.4.3.5 shall not apply where there is a heavy buildup of residue. (See 6.1.2.)

**6.4.3.6** Where local application nozzles are used for protection across openings as defined in 5.2.1.4 and 5.2.1.5, the area per nozzle given by specific approval or listing shall be permitted to be increased to a maximum of 20 percent.

**6.4.3.7** Where deep-layer flammable liquid fires are to be protected, a minimum freeboard of 6 in. (152 mm) shall be provided unless otherwise noted in approvals or listings of nozzles.

**6.4.4 Location and Number of Nozzles.** A quantity of nozzles shall be used to cover the entire hazard area on the basis of the unit areas protected by each nozzle.

**6.4.4.1** Tankside or linear nozzles shall be located in accordance with spacing and discharge rate limitations stated in specific approvals or listings.

**6.4.4.2** Overhead-type nozzles shall be installed perpendicular to the hazard and centered over the area protected by the nozzle.

**6.4.4.2.1** Overhead-type nozzles shall also be permitted to be installed at angles between 45 degrees and 90 degrees from the plane of the hazard surface as prescribed in 6.4.4.3.

**6.4.4.2.2** The height used in determining the necessary flow rate and area coverage shall be the distance from the aiming point on the protected surface to the face of the nozzle measured along the axis of the nozzle.

**6.4.4.3 Nozzles Installed at an Angle.**

**6.4.4.3.1** When nozzles are installed at an angle, they shall be aimed at a point measured from the near side of the area protected by the nozzle.

**6.4.4.3.2** This location shall be calculated by multiplying the fractional aiming factor in Table 6.4.4.3.2 by the width of the area protected by the nozzle.

**6.4.4.4** Nozzles shall be located so as to be free of possible obstructions that could interfere with the projection of the discharged carbon dioxide.

**6.4.4.5\*** Nozzles shall be located so as to develop an extinguishing atmosphere over coated stock extending above a protected surface.

**Table 6.4.4.3.2 Aiming Factors for Angular Placement of Nozzles, Based on 6 in. (152 mm) Freeboard**

Discharge Angle*	Aiming Factors†
45–60	$\frac{1}{4}$
60–75	$\frac{1}{4}$ – $\frac{3}{8}$
75–90	$\frac{3}{8}$ – $\frac{1}{2}$
90 (perpendicular)	$\frac{1}{2}$ (center)

\*Degrees from plane of hazard surface.

†Fractional amount of nozzle coverage area.

**6.4.4.6** The possible effects of air currents, winds, and forced drafts shall be compensated for by nozzle locations or by providing additional nozzles to protect the outside areas of the hazard.

**6.5 Rate-by-Volume Method.**

**6.5.1\* General.** The volume method of system design shall be used where the fire hazard consists of three-dimensional irregular objects that cannot be easily reduced to equivalent surface areas.

**6.5.2 Assumed Enclosure.** The total discharge rate of the system shall be based on the volume of an assumed enclosure entirely surrounding the hazard.

**6.5.2.1** The assumed enclosure shall be based on an actual closed floor unless special provisions are made to take care of bottom conditions.

**6.5.2.2** The assumed walls and ceiling of this enclosure shall be at least 2 ft (0.6 m) from the main hazard unless actual walls are involved, and they shall enclose all areas of possible leakage, splashing, or spillage.

**6.5.2.3** No deductions shall be made for solid objects within this volume.

**6.5.2.4** A minimum dimension of 4 ft (1.2 m) shall be used in calculating the volume of the assumed enclosure.

**6.5.2.5** If the hazard can be subjected to winds or forced drafts, the assumed volume shall be increased to compensate for losses on the windward sides.

**6.5.3 System Discharge Rate.**

**6.5.3.1** The total discharge rate for the basic system shall be equal to 1 lb/min·ft<sup>3</sup> (16 kg/min·m<sup>3</sup>) of assumed volume.

**6.5.3.2\*** If the assumed enclosure has a closed floor and is partly defined by permanent continuous walls extending at least 2 ft (0.6 m) above the hazard (where the walls are not normally a part of the hazard), the discharge rate shall be permitted to be proportionately reduced to not less than 0.25 lb/min·ft<sup>3</sup> (4 kg/min·m<sup>3</sup>) for actual walls completely surrounding the enclosure.

**6.5.4 Location and Number of Nozzles.** A quantity of nozzles shall be used to cover the entire hazard volume on the basis of the system discharge rate as determined by the assumed volume.

**6.5.4.1** Nozzles shall be located and directed so as to retain the discharged carbon dioxide in the hazard volume by cooperation between nozzles and objects in the hazard volume.

**6.5.4.2** Nozzles shall be located so as to compensate for any possible effects of air currents, winds, or forced drafts.

**6.5.4.3** The design discharge rates through individual nozzles shall be determined on the basis of location or projection distance in accordance with specific approvals or listings for surface fires.

## **6.6 Distribution System.**

**6.6.1 General.** The system shall be designed to provide an effective discharge of carbon dioxide promptly before excessive amounts of heat can be absorbed by materials within the hazard.

**6.6.1.1** The carbon dioxide supply shall be located as near to the hazard as practicable and yet not be exposed to the fire, and the pipeline shall be as direct as practicable with a minimum number of turns in order to get carbon dioxide to the fire promptly.

**6.6.1.2** The system shall be designed for automatic operation except where the authorities having jurisdiction permit manual operation.

**6.6.2\* Piping Systems.** Piping shall be designed in accordance with 4.7.5 to deliver the required rate of application at each nozzle.

**6.6.3 Discharge Nozzles.** The nozzles used shall be listed or approved for rate of discharge, effective range, and pattern or area coverage.

**6.6.3.1** The equivalent orifice size used in each nozzle shall be determined in accordance with 4.7.5 to match the design discharge rate.

**6.6.3.2** Nozzles shall be accurately located and directed in accordance with the system design requirements as covered in Sections 6.4 and 6.5.

## **Chapter 7 Hand Hose Line Systems**

### **7.1 General Information.**

**7.1.1\* Description.** Hand hose line systems shall consist of a hose reel or rack, hose, and a discharge nozzle assembly connected by fixed piping to a supply of carbon dioxide.

**7.1.2 Uses.** Hand hose line systems shall be permitted to be used to supplement fixed fire protection systems or to supplement first aid fire extinguishers for the protection of specific hazards for which carbon dioxide is the extinguishing agent.

**7.1.2.1** These systems shall not be used as a substitute for other fixed carbon dioxide fire-extinguishing systems equipped with fixed nozzles, except where the hazard cannot adequately or economically be provided with fixed protection.

**7.1.2.2** The decision as to whether hose lines are applicable to the particular hazard shall rest with the authority having jurisdiction.

**7.1.3 General Requirements.** Hand hose line systems shall be installed and maintained in accordance with the applicable requirements of Chapters 4 through 6, except as outlined in Sections 7.2 through 7.6.

### **7.1.4\* Safety Requirements.**

**7.2 Hazard Specifications.** Hand hose line systems shall be permitted to be used to combat fires in all hazards covered under Chapter 1, except those that are inaccessible and beyond the scope of manual fire fighting.

### **7.3 Location and Spacing.**

#### **7.3.1 Location.**

**7.3.1.1** Hand hose line stations shall be placed such that they are easily accessible and within reach of the most distant hazard that they are expected to protect.

**7.3.1.2** In general, hand hose line stations shall not be located such that they are exposed to the hazard, nor shall they be located inside any hazard area protected by a total flooding system.

**7.3.2 Spacing.** If multiple hose stations are used, they shall be spaced so that any area within the hazard can be covered by one or more hose lines.

### **7.4 Carbon Dioxide Requirements.**

#### **7.4.1 Rate and Duration of Discharge.**

**7.4.1.1** The rate and duration of discharge, and consequently the amount of carbon dioxide, shall be determined by the type and potential size of the hazard.

**7.4.1.2** A hand hose line shall have a quantity of carbon dioxide to permit its use for at least 1 minute.

**7.4.2 Provision for Use by Inexperienced Personnel.** The possibility of these hose lines being used by inexperienced personnel shall be considered, and a provision shall be made so that there will be a supply of carbon dioxide to enable personnel to effect extinguishment of the hazards that they are likely to encounter.

#### **7.4.3 Simultaneous Use.**

**7.4.3.1** Where simultaneous use of two or more hose lines is possible, a quantity of carbon dioxide shall be available to support the maximum number of nozzles that are likely to be used at any one time for at least 1 minute.

**7.4.3.2** All supply piping shall be sized for the simultaneous operation of the number of nozzles that are likely to be used.

### **7.5 Equipment Specifications.**

**7.5.1 Hose.** Hose lines on systems with high-pressure supply shall have a minimum bursting pressure of 5000 psi (34,474 kPa), and hose lines of systems with low-pressure supply shall have a minimum bursting pressure of 1800 psi (12,411 kPa). (See 4.8.2.)

**7.5.2\* Discharge Nozzle Assembly.** Hose lines shall be equipped with a discharge nozzle assembly that can be easily handled by one operator and that contains a quick-opening shutoff valve to control the flow of carbon dioxide through the nozzle and a handle for directing the discharge.

#### **7.5.3 Hose Line Storage.**

**7.5.3.1** The hose shall be coiled on a hose reel or rack such that it will be ready for immediate use without the necessity of coupling and such that it can be uncoiled with a minimum of delay.

**7.5.3.2** If installed outdoors, the hose line shall be protected against the weather.

#### **7.5.4\* Charging the Hose Line.**

**7.5.4.1** All controls for actuating the system shall be located in the immediate vicinity of the hose reel.

**7.5.4.2\*** The carbon dioxide supply shall be located as close to the hose reel as possible so that liquid carbon dioxide will be supplied to the hose line with a minimum of delay after actuation.

**7.5.4.3** Except when in actual use, pressure shall not be permitted to remain in the hose line.

#### **7.6 Training.**

**7.6.1** Successful extinguishment of fire with hand hose lines greatly depends on the individual ability and technique of the operator.

**7.6.2** All personnel who are likely to use this equipment at the time of a fire shall be trained in its operation and in the fire-fighting techniques applicable to this equipment.

### **Chapter 8 Standpipe Systems and Mobile Supply**

#### **8.1 General Information.**

**8.1.1\* Description.** A standpipe system shall be a fixed total flooding, local application, or hand hose line system without a permanently connected carbon dioxide supply.

**8.1.2\* Uses.** Standpipe systems shall be installed only with the approval of the authority having jurisdiction.

**8.1.3 General Requirements.** Standpipe systems and mobile supply shall be installed and maintained in accordance with the requirements in Chapters 4 through 7, in addition to those outlined in Sections 8.2 through 8.5.

**8.1.3.1** Piping shall be installed in accordance with the requirements applicable for the system if a permanently connected supply is used.

**8.1.3.2** Appreciable lengths of piping on the portable supply shall be taken into account.

**8.2 Hazard Specifications.** Standpipe systems and mobile supply shall be permitted to be used to protect hazards described in Chapters 4 through 7, where extinguishment will not be adversely affected by the delay in obtaining effective discharge of carbon dioxide while the mobile supply is being brought to the scene and coupled to the standpipe system.

#### **8.3 Standpipe Requirements.**

**8.3.1** The supply piping of standpipe systems shall be equipped with quick-change couplings and shall terminate in an easily accessible and well-marked location for connection to the mobile supply.

**8.3.2** This location shall be marked with the amount of carbon dioxide required and the required duration of discharge.

#### **8.4 Mobile Supply Requirements.**

**8.4.1\* Capacity.** The mobile supply shall have a capacity in accordance with the provisions of Chapters 4 through 7.

#### **8.4.2 Coupling.**

**8.4.2.1** The mobile supply shall be provided with a means for transferring carbon dioxide into the standpipe system.

**8.4.2.2** Quick-change couplings shall be provided to permit these connections to be made as rapidly as possible.

#### **8.4.3 Mobility.**

**8.4.3.1** The storage container or containers of carbon dioxide shall be mounted on a movable vehicle that can be brought to the scene of the fire by manual means, by a separate motor vehicle, or under its own power.

**8.4.3.2** The means of transporting the mobile supply shall be dependable and capable of getting to the fire with a minimum of delay.

**8.4.4 Location.** The mobile supply shall be kept close to the hazards that it is intended to protect so that fire extinguishment can be started as soon as possible after the fire breaks out.

**8.4.5 Accessories.** The mobile supply for standpipe systems shall be permitted to be provided with hand hose lines as accessory equipment for the protection of small scattered hazards or as a supplement to standpipe systems or other fixed protection.

**8.5\* Training.** It is imperative that those persons assigned to the units shall be trained in the use and maintenance of the standpipe systems and mobile supply.

### **Chapter 9 Marine Systems**

**9.1 Special Definitions.** The following definitions shall apply to Chapter 9:

- (1) Marine systems (*See 3.4.1.*)
- (2) Space
  - (a) Cargo space (*See 3.4.2.1.*)
  - (b) Electrical equipment space (*See 3.4.2.2.*)
  - (c)\* Machinery space (*See 3.4.2.3.*)
  - (d)\* Vehicle space (*See 3.4.2.4.*)

#### **9.2 General.**

**9.2.1\* Outline.** This chapter outlines the modifications necessary for marine systems.

**9.2.2** All other requirements of this standard shall apply to marine systems except as modified by this chapter.

#### **9.3 System Requirements.**

**9.3.1 Components.** System components shall be specifically listed or approved for carbon dioxide system marine applications.

#### **9.3.2 Operating Instructions.**

**9.3.2.1** Instructions for the operation of the system shall be located in a conspicuous place at or near all manual controls and in the carbon dioxide storage room.

**9.3.2.2** For systems in which the carbon dioxide storage is not within the protected space, the operating instructions shall include a chart indicating the location of the emergency control to be used if the normal controls fail to operate.



### 9.3.3 Actuation.

**9.3.3.1\*** For spaces greater than 6000 ft<sup>3</sup> (170 m<sup>3</sup>), automatic release of the carbon dioxide system shall not be permitted.

**9.3.3.2\*** Automatic release shall be permitted for any space of 6000 ft<sup>3</sup> (170 m<sup>3</sup>) or less, provided the requirements of 9.3.3.2.1 through 9.3.3.2.4 are met.

**9.3.3.2.1** Horizontal means of egress from the machinery enclosure to the open deck shall be provided.

**9.3.3.2.2** The enclosure shall be unmanned during any operation of the equipment.

**9.3.3.2.3** The system shall be locked out when persons are present within the enclosure.

**9.3.3.2.4** Automatic actuation of the system shall not interfere with safe navigation of the vessel.

**9.3.3.3** For manual operation, two separate valves shall be provided for releasing carbon dioxide into any protected space.

**9.3.3.3.1** One valve shall control discharge from the carbon dioxide storage.

**9.3.3.3.2** The second valve shall control carbon dioxide discharge into the protected space(s).

**9.3.3.3.3** For systems that contain 300 lb (136 kg) of carbon dioxide storage or less, only one valve shall be required to be used for the release of the system, provided that the protected space is normally unoccupied and has horizontal egress.

#### 9.3.3.4\* Controls.

**9.3.3.4.1** A separate manually operated control shall be provided to operate each valve required by 9.3.3.3.

**9.3.3.4.2** A set of controls shall be located outside at least one of the main means of egress from each protected space.

**9.3.3.5\*** In addition to the manually operated controls required by 9.3.3.4, each of the valves required by 9.3.3.3 shall be provided with its own emergency manual control.

#### 9.3.3.6 Release Box.

**9.3.3.6.1** Controls for the valves required by 9.3.3.4 shall be located inside a release box clearly identified for the protected space.

**9.3.3.6.2** If the box containing the controls is to be locked, a key to the box shall be provided in a break-glass-type enclosure conspicuously located adjacent to the box.

#### 9.3.3.7\* Source of Power.

**9.3.3.7.1** In addition to the requirements of 4.3.3.2, audible pre-discharge alarms shall be provided that depend on no source of power other than carbon dioxide pressure.

**9.3.3.7.2** The time delay required by 4.5.6.2.2 shall be a minimum of 20 seconds and shall depend on no source of power other than carbon dioxide pressure.

### 9.3.4 Carbon Dioxide Storage.

**9.3.4.1** Carbon dioxide storage shall be permitted inside normally unoccupied protected spaces for systems that contain not more than 300 lb (136 kg) of carbon dioxide storage and are equipped for automatic actuation.

**9.3.4.2** Low-pressure systems shall be provided with dual refrigeration units and shall be constructed in accordance with 46 CFR 58.20.

**9.3.4.3** When the carbon dioxide containers are located outside a protected space, they shall be stored in a room that shall be situated in a safe and readily accessible location and shall be effectively ventilated so that the agent containers are not exposed to ambient temperatures outlined in 4.6.5.5.

**9.3.4.3.1** Common bulkheads and decks located between agent container storage rooms and protected spaces shall be protected with A-60 class structural insulation as defined by 46 CFR 72.

**9.3.4.3.2** Doors and other means of closing any opening therein that form the boundaries between such rooms and adjoining protected spaces shall be gastight.

**9.3.4.3.3** Agent container storage rooms shall be accessible without having to pass through the space being protected.

**9.3.4.3.4** Access doors shall open outward.

**9.3.4.3.5** For systems that contain 300 lb (136 kg) of carbon dioxide storage or less, only one valve shall be required to be used for the release of the system, provided that the protected space is normally unoccupied and has horizontal egress.

### 9.3.5 System Piping.

**9.3.5.1** Where necessary, drains shall be provided for the removal of accumulated moisture.

**9.3.5.2** Carbon dioxide piping shall not be fitted with drains or other openings within living quarters.

**9.3.5.3** Carbon dioxide piping shall be used for no other purpose, except that carbon dioxide piping shall be permitted to be used in an air-sampling-type smoke detection system.

**9.3.6 System Design.** System design shall comply with Chapters 5 through 7 except as described in 9.3.6.1 through 9.3.6.4.2.

**9.3.6.1 Machinery Spaces.** Machinery spaces shall be designed to a 34 percent concentration based on the gross volume.

**9.3.6.1.1** Eighty-five percent of the concentration required by 9.3.6.1 shall be achieved within 2 minutes from the start of discharge.

**9.3.6.1.2** Gross volume shall include the casing.

**9.3.6.2 Cargo Spaces.** Cargo spaces other than vehicle spaces shall be supplied with carbon dioxide based on 1 lb/30 ft<sup>3</sup> based on the gross volume.

**9.3.6.2.1** The initial quantity of carbon dioxide discharged shall be based on the net volume of the space as determined by the amount of cargo in the cargo space.

**9.3.6.2.2\*** Additional carbon dioxide shall be released as needed to maintain control of the fire.

**9.3.6.2.3** Clear instructions shall be posted within the carbon dioxide storage room detailing the carbon dioxide release procedure.

### 9.3.6.3 Vehicle Spaces.

**9.3.6.3.1** Vehicle spaces where the vehicles contain more than 5 gal (19 L) of fuel (gasoline or diesel) shall be designed to a 34 percent concentration based on the gross volume.

**9.3.6.3.2** Eighty-five percent of this concentration shall be achieved within 2 minutes from start of discharge.

### 9.3.6.4 Vehicle Spaces.

**9.3.6.4.1** Vehicle spaces where the vehicles contain 5 gal (19 L) or less of fuel (gasoline or diesel) shall be designed to a 34 percent concentration based on the gross volume.

**9.3.6.4.2** Two-thirds of this concentration shall be achieved within 10 minutes from start of discharge.

**9.3.7 Electrical Equipment Spaces.** Electrical equipment spaces shall be treated as a dry electrical hazard in accordance with Chapter 5.

**Δ 9.4 Inspection and Maintenance.** Inspection and maintenance shall comply with 4.8.3 and Section 9.4.

**9.4.1 General.** Prior to testing or maintenance of a fixed carbon dioxide system, all personnel shall be evacuated from the protected space. (See Section 4.3.)

### 9.4.2 Approval of Installations.

**9.4.2.1** The approval test described in 9.4.2.1.1 through 9.4.2.1.4 shall be conducted prior to the tests required by 4.4.3.

**9.4.2.1.1** Pressure tests of the piping shall be performed to meet the requirements of 9.4.2.1.2 through 9.4.2.1.4.

**9.4.2.1.2** The test medium shall be a dry, noncorrosive gas such as nitrogen or carbon dioxide.

**9.4.2.1.3** When pressurizing the piping, pressure shall be increased in 50 psi (3.5 bar) increments.

**Δ 9.4.2.1.4** Once the pressure in the pipe has reached the required test pressure, the pressure source shall be shut off and disconnected from the pipe.

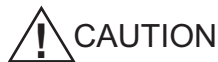

Pneumatic pressure testing creates a potential risk of injury to personnel in the area, as a result of airborne projectiles, if rupture of the piping system occurs. Prior to the pneumatic pressure test, the area in which the pipe is located shall be evacuated and appropriate safeguards shall be provided for test personnel.

### 9.4.2.2 High-Pressure Systems.

#### 9.4.2.2.1 Systems with Stop Valves.

**9.4.2.2.1.1** All piping from the carbon dioxide supply to the stop valves shall be subjected to a minimum pressure of 1000 psi (6895 kPa).

**9.4.2.2.1.2** The leakage during a 2-minute period shall not exceed a pressure drop of 10 percent.

**9.4.2.2.1.3** All piping between the stop valves and the nozzles shall be subjected to a minimum pressure of 600 psi (4137 kPa).

**9.4.2.2.1.4** The leakage during a 2-minute period shall not exceed a pressure drop of 10 percent.

#### 9.4.2.2.2 Systems Without Stop Valves.

**9.4.2.2.2.1** All piping from the carbon dioxide supply to the nozzles shall be subjected to a minimum pressure of 600 psi (4137 kPa).

**9.4.2.2.2.2** The leakage during a 2-minute period shall not exceed a pressure drop of 10 percent.

#### 9.4.2.3 Low-Pressure Systems.

##### 9.4.2.3.1 Normally Pressurized Piping.

**9.4.2.3.1.1** All piping that is normally pressurized shall be subjected to a minimum pressure test of 300 psi (2068 kPa).

**9.4.2.3.1.2** No leakage shall be permitted from the piping during a 2-minute test.

##### 9.4.2.3.2 Piping Between the Tank Shutoff Valve and Nozzles.

**9.4.2.3.2.1** All piping between the tank shutoff valve and the nozzles shall be subjected to a minimum pressure test of 300 psi (2068 kPa).

**9.4.2.3.2.2** The leakage during a 2-minute period shall not exceed a pressure drop of 10 percent.

#### 9.4.3 Predischage Delays, Alarms, and Shutdowns.

**9.4.3.1** Predischage delays and alarms and ventilation shutdowns shall be tested by flowing carbon dioxide into the system.

**9.4.3.2** Predischage delays that are not accurate to within +20 percent/-0 percent at 70°F (21°C) of their rating shall be replaced.

**9.4.4 Verification.** Compliance with 9.3.2 shall be verified.

## Annex A Explanatory Material

*Annex A is not a part of the requirements of this NFPA document but is included for informational purposes only. This annex contains explanatory material, numbered to correspond with the applicable text paragraphs.*

**A.1.1** Portable carbon dioxide equipment is covered in NFPA 10. The use of carbon dioxide for inerting is covered in NFPA 69.

**A.1.3.4** Exposure to carbon dioxide discharge poses a hazard to personnel; therefore, additional safety features for all new installations and for retrofitting of existing systems are provided in Section 4.3.

Safety to personnel is of paramount importance; therefore, these additional safety features should have been installed by December 31, 2008.

The addition of supervised lockout valves, per 4.3.3.4 and 4.3.3.4.1, and pneumatic predischage alarms and pneumatic time delays, per 4.5.5.8, require that the system flow calculations be verified and be in accordance with this standard. That is, the addition of piping equipment (valve and time delay) adds equivalent pipe length to the system. The pneumatic predischage alarm requires carbon dioxide flow to sound. The revised design should be in accordance with the agent quantity requirements of this standard.

These modifications could necessitate revisions to, upgrading of, or replacement of system components, including control units.

As part of the process of implementing these modifications, the authority having jurisdiction should be consulted for additional recommendations or requirements.

#### A.1.4 See Table A.1.4.

If a value for measurement as given in this standard is followed by an equivalent value in other units, the first value stated is to be regarded as the requirement. A given equivalent value can be approximate.

The conversion procedure for the SI units is to multiply the quantity by the conversion factor and then round the result to the appropriate number of significant digits.

**A.3.2.1 Approved.** The National Fire Protection Association does not approve, inspect, or certify any installations, procedures, equipment, or materials; nor does it approve or evaluate testing laboratories. In determining the acceptability of installations, procedures, equipment, or materials, the authority having jurisdiction may base acceptance on compliance with NFPA or other appropriate standards. In the absence of such standards, said authority may require evidence of proper installation, procedure, or use. The authority having jurisdiction may also refer to the listings or labeling practices of an organization that is concerned with product evaluations and is thus in a position to determine compliance with appropriate standards for the current production of listed items.

**A.3.2.2 Authority Having Jurisdiction (AHJ).** The phrase “authority having jurisdiction,” or its acronym AHJ, is used in NFPA documents in a broad manner, since jurisdictions and approval agencies vary, as do their responsibilities. Where public safety is primary, the authority having jurisdiction may be a federal, state, local, or other regional department or individual such as a fire chief; fire marshal; chief of a fire prevention bureau, labor department, or health department; building official; electrical inspector; or others having statutory authority. For insurance purposes, an insurance inspection department, rating bureau, or other insurance company representative may be the authority having jurisdiction. In many circumstances, the property owner or his or her designated agent assumes the role of the authority having jurisdiction; at government installations, the commanding officer or departmental official may be the authority having jurisdiction.

**A.3.2.4 Listed.** The means for identifying listed equipment may vary for each organization concerned with product evaluation; some organizations do not recognize equipment as listed unless it is also labeled. The authority having jurisdiction should utilize the system employed by the listing organization to identify a listed product.

**Table A.1.4 Units**

Name of Unit	Unit Symbol	Conversion Factor
pascal	Pa	1 psi = 6894.757 Pa
kilogram	kg	1 lb = 0.4536 kg
meter	m	1 ft = 0.3048 m
millimeter	mm	1 in. = 25.4 mm

Note: For additional conversions and information, see ASTM SI10.

**A.3.3.7 Normally Unoccupied Enclosure or Space.** A normally unoccupied enclosure or space is one that is occasionally visited by personnel. Examples of areas considered normally unoccupied are transformer bays, switch-houses, pump rooms, unattended vaults, engine test stands, cable vaults, cable spreading rooms, utility tunnels, microwave relay stations, unattended flammable liquid storage areas, enclosed energy systems, shipboard cargo holds, robotic paint spray areas, and computer room subfloors.

**A.3.3.9.1 High Pressure.** At 70°F (21°C), the pressure in this type of storage is 850 psi (5860 kPa).

**A.3.3.9.2 Low Pressure.** At this temperature, the pressure in this type of storage is 300 psi (2068 kPa).

**A.3.3.11.3 Pre-Engineered System.** Pre-engineered systems can incorporate special nozzles, flow rates, methods of application, nozzle placement, and quantities of carbon dioxide that could differ from those detailed elsewhere in this standard because they are designed for very specific hazards. All other requirements of the standard apply. It is possible for the normal manual control to qualify as the emergency manual control if the provisions of 4.5.1 are satisfied.

The hazards protected by these systems are specifically limited as to type and size. Limitations on hazards that can be protected by these systems are contained in the manufacturer's installation manual, which is referenced as part of the listing.

**A.4.2.1** The discharge of liquid carbon dioxide is known to produce electrostatic charges that, under certain conditions, could create a spark. (See NFPA 77.)

Carbon dioxide does not extinguish fires where the following materials are actively involved in the combustion process:

- (1) Chemicals containing their own oxygen supply, such as cellulose nitrate
- (2) Reactive metals such as sodium, potassium, magnesium, titanium, and zirconium
- (3) Metal hydrides

While carbon dioxide does not extinguish these fires, it does not react dangerously with these materials or increase their burning rate. Carbon dioxide, if used in this type of situation in a total flooding system, provides protection for adjacent combustibles or can be successfully used if the reactive metals or hydrides are first covered by another material. The following are examples of this latter condition:

- (1) Sodium stored or used under kerosene
- (2) Cellulose nitrate in solution of lacquer thinner
- (3) Magnesium chips covered with heavy oil

For local application systems with attendant high velocity, directed discharge should not be used.

**A.4.3** The steps and safeguards necessary to prevent injury or death to personnel in areas where atmospheres will be made hazardous by the discharge of carbon dioxide can include the following provisions:

- (1) Provisions of adequate aiseways and routes of exit and keeping them clear at all times
- (2) Provisions of necessary additional or emergency lighting, or both, and directional signs to ensure quick, safe evacuation

- (3) Provisions of alarms within such areas that operate immediately upon activation of the system on detection of the fire, with the discharge of the carbon dioxide and the activation of automatic door closures delayed for a sufficient time to evacuate the area before discharge begins
- (4) Provisions of only outward swinging, self-closing doors at exits from hazardous areas and, where such doors are latched, provisions of panic hardware
- (5) Provisions of continuous alarms at entrances to such areas until atmosphere has been restored to normal
- (6) Provisions of odor added to the carbon dioxide so that hazardous atmospheres in such areas can be recognized
- (7) Provisions of warning and instruction signs at entrances to and inside such areas
- (8) Provisions of prompt discovery and rescue of persons rendered unconscious in such areas. (This can be accomplished by having such areas searched by trained personnel equipped with proper breathing equipment immediately after carbon dioxide discharge stops. Those persons rendered unconscious by carbon dioxide can be restored by artificial respiration and without permanent injury if removed quickly from the hazardous atmosphere. Self-contained breathing equipment and personnel trained in its use and in rescue practices, including artificial respiration, should be readily available.)
- (9) Provisions of instruction and drills of all personnel within or in the vicinity of such areas, including maintenance or construction people who might be brought into the area, to ensure their correct action when carbon dioxide protection equipment operates
- (10) Provisions of means for prompt ventilation of such areas (Forced ventilation will often be necessary. Care should be taken to dissipate hazardous atmospheres, not merely move them to another location. Carbon dioxide is heavier than air.)
- (11) Provisions of other steps and safeguards necessary to prevent injury or death as indicated by careful study of particular situations

**A.4.3.1** The discharge of carbon dioxide in fire-extinguishing concentration creates serious hazards to personnel, such as suffocation and reduced visibility during and after the discharge period.

**A.4.3.1.3** It is recommended that self-contained breathing apparatus (SCBA) be provided for rescue purposes.

**A.4.3.3.3** Contact with carbon dioxide in the form of dry ice can cause frostbite.

**A.4.3.3.4.4** Lockout valves are to be installed on all total flooding systems as well as local application systems where carbon dioxide could migrate, creating a hazard to personnel. If persons are located in areas from which they cannot easily exit the protected space or spaces directly adjacent to protected spaces within the system's time delay period, the system should be locked out.

**A.4.3.3.5** Cylinder outlets should be fitted with safety covers or anti-recoil devices whenever the cylinder is not connected to the system piping.

**A.4.3.4.1** As used in this standard, clearance is the air distance between equipment, including piping and nozzles, and unenclosed or uninsulated live electrical components at other than ground potential. The minimum clearances listed in Table 4.3.4.1 are for the purpose of electrical clearance under normal conditions; they are not intended for use as "safe" distances during fixed system operation.

The clearances given in Table 4.3.4.1 and Figure 4.3.4.1 are for altitudes of 3300 ft (1000 m) or less.

**A.4.3.4.2** The clearances are based on minimum general practices related to design basic insulation level (BIL) values.

**A.4.3.4.3** For electrical system voltages up to 161 kV, the design BIL kilovolts and corresponding minimum clearances, phase to ground, have been established through long usage.

At voltages higher than 161 kV, uniformity in the relationship between design BIL kilovolts and the various electrical system voltages has not been established in practice. For these higher system voltages, it is common practice to use BILs dependent on the degree of protection that is to be obtained. For example, in 230 kV systems, BILs of 1050, 900, 825, 750, and 650 kV have been utilized.

Required clearance to ground can also be affected by switching surge duty, a power system design factor that, along with BIL, must correlate with selected minimum clearances. Electrical design engineers can furnish clearances dictated by switching surge duty. Table 4.3.4.1 and Figure 4.3.4.1 deal only with clearances required by design BILs.

**A.4.3.4.4** Possible design variations in the clearance required at higher voltages are evident in Table 4.3.4.1, where a range of BIL values are indicated opposite the various voltages in the high-voltage portion of the table.

**A.4.3.5** An effective concentration of agent is equally important in all classes of fires because a persistent ignition source (e.g., an arc, heat source, oxyacetylene torch, or deep-seated fire) can lead to a recurrence of the initial event once the agent has dissipated.

**A.4.3.6** Visible appliances are not required to comply with the mounting heights and light pulse characteristics of *NFPA 72*, so rotating beacons or other visible appliances are permitted to be used. Visibility throughout the space, including the reflection of light being visible on surfaces, complies with this requirement.

**A.4.4.3** Manufacturers of fire suppression system equipment should make available, upon request, the manufacturer's design, installation, and maintenance manual and product safety bulletins to the authority having jurisdiction.

**A.4.4.3.1** A sample test report is provided in Figure A.4.4.3.1. An alternative form that ensures that all the applicable design, operational, and safety requirements of this standard are documented to the satisfaction of the authority having jurisdiction can be used.

**▲ A.4.4.3.2** FM Approvals 5420 should be consulted for possible listing requirements.



<b>Carbon Dioxide System Acceptance Test Report</b>	
<b>PROCEDURE</b>	
Upon completion of work, an inspection and test shall be made by the contractor's representative and witnessed by an owner's representative. All defects shall be corrected and the system left in service before contractor's personnel leave the job. A certificate shall be filled out and signed by both representatives. Copies shall be prepared for approving authorities, owners, and contractor. It is understood the owner's representative's signature in no way prejudices any claim against contractor for faulty material, poor workmanship, or failure to comply with approving authority's requirements or local ordinances.	
Property name:	Date:
Property address:	
<b>Plans</b>	Accepted by approving authorities (names):
	Address:
	Installation conforms to accepted plans. <input type="checkbox"/> Yes <input type="checkbox"/> No Equipment used is approved. <input type="checkbox"/> Yes <input type="checkbox"/> No If no, explain deviations:
<b>Instructions</b>	Has person in charge of fire equipment been instructed as to location of control valves and care and maintenance of this new equipment? If no, explain: <input type="checkbox"/> Yes <input type="checkbox"/> No
	Have copies of appropriate instructions and care and maintenance charts been left on premises? If no, explain: <input type="checkbox"/> Yes <input type="checkbox"/> No
<b>Location</b>	Building or area protected Explain:
<b>CO<sub>2</sub> equipment</b>	Carbon dioxide appropriate use? <input type="checkbox"/> Yes <input type="checkbox"/> No
	Normally occupied enclosures? <input type="checkbox"/> Yes <input type="checkbox"/> No
	Assumed enclosure:
	System type: <input type="checkbox"/> High pressure <input type="checkbox"/> Low pressure <input type="checkbox"/> Local app. <input type="checkbox"/> Total flooding <input type="checkbox"/> Engineered <input type="checkbox"/> Pre-engineered
	Piping, equipment, and discharge nozzles proper size and location? <input type="checkbox"/> Yes <input type="checkbox"/> No
	Location of alarms and manual emergency releases acceptable? <input type="checkbox"/> Yes <input type="checkbox"/> No
Current hazard configuration comparable to original configuration? <input type="checkbox"/> Yes <input type="checkbox"/> No	
Enclosure of hazard sealed properly? <input type="checkbox"/> Yes <input type="checkbox"/> No	
All installed equipment listed for use? <input type="checkbox"/> Yes <input type="checkbox"/> No	
<b>Pipe and fittings</b>	Pipe types and class:
	Pipe conforms to Standard <input type="checkbox"/> Yes <input type="checkbox"/> No
	Fittings conform to Standard <input type="checkbox"/> Yes <input type="checkbox"/> No If no, explain:
<b>Operational test</b>	Full operational test for single or multiple hazards: Operational test of devices, including detection and actuation devices? <input type="checkbox"/> Yes <input type="checkbox"/> No
	Local application: Design quantity CO <sub>2</sub> through piping system effectively covers hazard for full time required? <input type="checkbox"/> Yes <input type="checkbox"/> No
	Total flooding: Design quantity CO <sub>2</sub> through piping system effectively covers hazard for full time required and concentration level is achieved and maintained? <input type="checkbox"/> Yes <input type="checkbox"/> No
	Hand hose lines: Verification of liquid flow from each nozzle with adequate pattern of coverage per design. <input type="checkbox"/> Yes <input type="checkbox"/> No
<b>Signatures</b>	Name of installing contractor: _____
	Tests witnessed by:
	For property owner: Title: _____ Date: _____ For contractor: Title: _____ Date: _____
Notes:	
© 2017 National Fire Protection Association	
NFPA 12	

▲ FIGURE A.4.4.3.1 Sample Acceptance Test Report.

**A.4.4.3.3.4** It is anticipated that full discharge tests will be waived by the authority having jurisdiction only under extremely unusual conditions. Factors such as extra cost and interruptions to production or business operations are not considered valid reasons for waiver of full discharge tests.

The full discharge test is intended to verify the full functionality of the system in accordance with 4.4.4. The test should verify the following:

- (1) That all of the carbon dioxide cylinders open as intended. This can be verified by checking the liquid level gauge on a low-pressure supply or by weighing each cylinder of a high-pressure system. Measurements should be taken before and after discharge.
- (2) That carbon dioxide flows through the pipe network and discharges from each nozzle as intended. This can be verified visually or by use of blow-off caps. Where piping is not normally under pressure, it is possibly not bubble-tight. However, where a slow discharge is involved, or if under continual pressure, bubbletightness should be achieved.
- (3) That the time delays, notification appliances, and system interlocks, such as damper closures and/or power shut-down, operate as intended.
- (4) That the discharge performance meets or exceeds the minimum design criteria.
  - (a) For total flooding systems, that a sufficient concentration of carbon dioxide is developed within the maximum time and is held for the intended duration. The carbon dioxide concentration can be verified by use of a gas analyzer or by another means acceptable to the authority having jurisdiction. The sample locations should be selected to show that the extinguishing concentration is achieved throughout the enclosure. The time to achieve the design concentration is measured from the time that the concentration measurement rises above zero to the time at which the benchmark concentration is indicated by the measuring device. Refer to 5.5.2.1 and 5.5.2.3 for the time requirements for total flooding systems.
  - (b) For local application systems, that the duration of the liquid discharge meets the design requirements and that the discharge provides adequate coverage on or around the hazard. The discharge duration should be measured at the nozzles with a stopwatch. For local application systems, the watch should be started when all nozzles flow liquid and stopped when the discharge changes from liquid to gas at any nozzle. See 6.3.3 and A.6.3.3.2. Coverage on or around the hazard is visually observed. It is useful, but not required, to use video of the discharge to aid in determining if adequate CO<sub>2</sub> coverage is developed during the discharge test.

Prior to the test, personnel should be warned and removed from the area. The local fire department and any remote monitoring stations should also be notified that a test is being conducted. Following the test, the system should be recharged and reset. For more specific instructions, consult the system manufacturer's installation manual, which should outline the system acceptance test procedures.

**A.4.5.1.3** The emergency manual control is intended for use only in the event of failure of automatic or normal manual actuation.

**A.4.5.2** Modern solid-state circuits, including microprocessors, are capable of responding to extremely short electrical impulses. While response to such transient signals is a desirable characteristic for some types of devices, it is an extremely undesirable characteristic for control units used to discharge carbon dioxide. Control units for releasing carbon dioxide systems must be designed to prevent unwanted discharges due to transient electrical impulses and to actuate predischARGE alarms and time delays before discharging carbon dioxide. Undesired transient impulses can be introduced into the control panel from sources external to the panel, or unwanted transients can be generated within the control panel itself.

For example, a microprocessor could produce undesired transient impulses for various reasons. Designs must incorporate technology to prevent discharge of carbon dioxide in the event that a microprocessor in the control unit emits spurious signals. If circuits that initiate carbon dioxide discharge are not designed to ignore such transients, an unwanted discharge could result.

**A.4.5.2.1** Technology is available to require actuation of predischARGE time delays and alarms before actuating circuits to discharge carbon dioxide. This technology should be incorporated into control units that release carbon dioxide systems.

Control units must be designed so that the normal failure mode of the circuitry that releases carbon dioxide is to not discharge the carbon dioxide.

The emergency manual release required in 4.5.1.3.1 of this standard provides a means to discharge carbon dioxide in case the electrical controls fail to cause a required discharge.

**A.4.5.3** Detectors installed at the maximum spacing as listed or approved for fire alarm use can result in excessive delay in agent release.

For additional information on detectors, refer to *NFPA 72*.

The *FSSA Application Guide Detection & Control for Fire Suppression Systems* offers the designer information on the various types of detection and control equipment.

**A.4.5.4.5** It is intended that initial actuation of a system by means of a normal manual control will result in a complete time delay sequence prior to system discharge. If system actuation is initiated by automatic means, subsequent operation of a normal manual control should not restart the time delay sequence.

**A.4.5.4.6** It is possible for the normal manual control to qualify as the emergency manual control if the provisions of 4.5.1 are satisfied. If possible, the system should be designed so that emergency actuation can be accomplished from one location.

The valve design should prevent either a discharge hose or accessory or an actuation device from being advertently or inadvertently connected to a valve incorrectly. This design would require the connection forms on the valve ports to be distinctive from each other, to prevent attachment of a device to the incorrect connection port.

**A.4.5.4.7** It is not the intent of this standard to prohibit the use of more pilot cylinders than the minimum number required in this paragraph.

On systems using discharge pressure from pilot cylinders (discharge manifold back pressure) to activate the slave cylinders, one more pilot cylinder than the minimum required to actuate the system is installed. This requirement provides assurance that the system will completely discharge even if one of the pilot cylinders has leaked.

**A.4.5.4.7.4** Modern solid-state circuits, including microprocessors, are capable of responding to extremely short electrical impulses. While response to such transient signals is a desirable characteristic for some types of devices, it is an extremely undesirable characteristic for control units used to discharge carbon dioxide. Control units for releasing carbon dioxide systems must be designed to prevent unwanted discharges due to transient electrical impulses and to actuate predischARGE alarms and time delays before discharging carbon dioxide.

Control units must be designed so that the normal failure mode of the circuitry that releases carbon dioxide is to not discharge the carbon dioxide. The emergency manual release required in 4.5.1.3 of this standard provides a means to discharge carbon dioxide in case the electrical controls fail to cause a required discharge.

**A.4.5.5.3** Examples of interconnections between the components that are necessary for the control of the system and life safety are detection, actuation, alarms, power sources, main tank shutoff valve, pilot vapor supply valve, and lockout devices.

**A.4.5.6** Refer to *NFPA 72* for guidance for installation of referenced visible alarms. The public mode for visible appliance operation should be used.

**A.4.5.6.2.3** Examples of hazard areas where the provision of a time delay could result in unacceptable risk to personnel or unacceptable damage to critical pieces of equipment are combustion gas turbines and engine test cells. Fires in such equipment tend to be fast growth, and delay in the discharge of the fire-extinguishing agent can result in destruction of essential equipment or unacceptable risk to personnel. These are normally unoccupied spaces. When such spaces are occupied by personnel, the systems must be locked out to prevent discharge of carbon dioxide without the benefit of a predischARGE alarm and time delay.

Where pneumatic time delays are not provided for normally unoccupied hazards, documented procedural control of access by personnel to the protected area should be enforced. The procedures should require lockout/tagout of the carbon dioxide system anytime the protected space is entered by personnel. Documentation and records should be provided to the authority having jurisdiction to verify that all procedures are being enforced.

**A.4.5.6.3.2** All total flood hazards will be made unsafe for entry of unprotected personnel until such spaces are ventilated of carbon dioxide. Spaces containing equipment protected by local application systems could become unsafe, particularly if the protected equipment occupies a sizable portion of the volume of the room containing the equipment. Pits, cellars, and rooms adjacent to the protected hazard, especially those at lower elevations, can be made unsafe by migration of the discharged carbon dioxide.

Oil of wintergreen is a common and recommended odorizer addition to the discharging carbon dioxide to produce a distinctive odor that warns of the presence of carbon dioxide gas. Other odorizers that are especially appropriate for specific locations can also be used, but, if there is no specific reason to use an odorizer other than oil of wintergreen, oil of wintergreen should be used.

Olfactory indicators could be inappropriate for such applications used in cleanrooms, food processing plants, aluminum rolling mills, and telecommunications facilities because they could adversely affect the process or equipment.

Provisions to help prevent the entry of persons into areas made unsafe by the discharge of carbon dioxide could include one or more of the following:

- (1) Addition of a distinctive odor to the discharging carbon dioxide, the detection of which serves as an indication to persons that carbon dioxide gases are present. Personnel should be trained to recognize the odor and evacuate spaces wherein the odor is detected.
- (2) Provision of automatic alarms at the entry to and within such spaces for which alarms are activated by carbon dioxide detectors or oxygen detectors
- (3) Establishment and enforcement of confined space entry procedures for such areas

**A.4.5.6.5** Alarm(s) should be connected to existing protective signaling (fire alarm) system(s) to aid life safety and property protection as outlined in *NFPA 72* and *NFPA 101*.

**A.4.6.1** Not all of the carbon dioxide in the low-pressure container can be rapidly discharged. As the storage container empties, a quantity of cold carbon dioxide vapor remains in the container. The quantity of this residual vapor varies, depending on the physical configuration of the container. This residual vapor should be considered in determining the storage capacity.

**A.4.6.3** Carbon dioxide, as normally manufactured, is an extremely pure product. In general, the industry produces only one grade or quality. This grade is considered suitable for all applications, including food and medical uses.

Dry carbon dioxide gas or liquid is completely noncorrosive to the containers. Carbon dioxide containing excess water can cause some corrosion in high-pressure cylinders, particularly in lightweight cylinders that are highly stressed. Excess water is present when the amount exceeds the normal solubility in liquid carbon dioxide, so water can condense on the walls of the container.

Carbon dioxide produced in modern low-pressure plants must necessarily have a very low water content to avoid operating difficulties. The normal practice is to maintain the water content below about 0.0032 percent (32 ppm) by weight. If this dry product is stored and transported in clean bulk low-pressure equipment, the quality will be maintained until it is used.

Dry ice normally contains more water and oil than does liquid carbon dioxide. It also tends to freeze moisture and other impurities from the atmosphere because of its very low temperature of  $-109.3^{\circ}\text{F}$  ( $-79^{\circ}\text{C}$ ). When dry ice is placed in a converter and allowed to warm up so that it becomes liquid carbon dioxide, the liquid so produced will obviously contain an excess amount of water. This liquid should not be used to



charge fire-extinguishing cylinders, unless it is further processed through a dehydrating unit to remove the excess water. It should also be noted that such dehydrating units can become ineffective unless the drying agent is renewed or reactivated as necessary to maintain its drying ability.

There are still a few high-pressure carbon dioxide production plants in service. The carbon dioxide produced in these plants could also contain excess water, unless the dehydrating equipment is kept in good condition. The only way to be assured of proper quality is to analyze periodically the carbon dioxide supply used for charging fire protection systems.

**A.4.6.5** In high-pressure storage systems, the temperature of the contained carbon dioxide depends on the ambient temperature at the storage location. The containers must therefore be capable of withstanding the pressures developed at the highest expected temperature.

The maximum pressure in the cylinder is also affected by the filling density or percent filling, which is the ratio expressed in the percentage of the carbon dioxide weight to the water capacity in pounds. The filling density commonly used is between 60 percent and 68 percent, the latter being the maximum allowed by the U.S. Department of Transportation (DOT) in Sections 178.36 and 178.37 of 49 CFR 171–190. Proper filling is determined by weight stamped on the valve body.

**A.4.6.5.2** Transporting a charged cylinder might be illegal if the cylinder has been damaged or exposed to fire. Federal and local regulations should be consulted.

The *FSSA Test Guide for Use with Special Hazard Fire Suppression Systems Containers*, provides useful information on testing requirements and safety precautions for handling and transporting high-pressure carbon dioxide cylinders.

A typical high-pressure storage facility using a number of cylinders is shown in Figure A.4.6.5.2. A flexible connector is used between each cylinder and the common manifold to facilitate the weight checking of cylinders and replacing them after use. Each cylinder is provided with its own valve with a dip tube extending to the bottom. Some older types of cylinders do not have dip tubes and are installed upside down to ensure discharge of liquid carbon dioxide.

**A.4.6.6** In low-pressure storage systems, the temperature of the contained carbon dioxide is controlled at about 0°F (–18°C) by means of insulation and refrigeration. The normal pressure is thus maintained at about 300 psi (2068 kPa). Welded pressure vessels are used for this service, and there is no special limitation on size.

The filling density has no effect on the pressure as long as there is sufficient vapor space to allow for expansion of the liquid at the maximum storage temperature and pressure. This filling density would be determined by the setting of the pressure relief valves. In general, the filling density can range from 90 percent to 95 percent. The maximum liquid level is controlled, during filling, by means of a short dip tube that returns excess liquid to the delivery unit when the liquid reaches the maximum filling level in the storage unit. A liquid level gauge is also provided to indicate the quantity of carbon dioxide in storage.

A typical low-pressure storage facility is shown in Figure A.4.6.6. In this unit, the insulated pressure vessel is covered

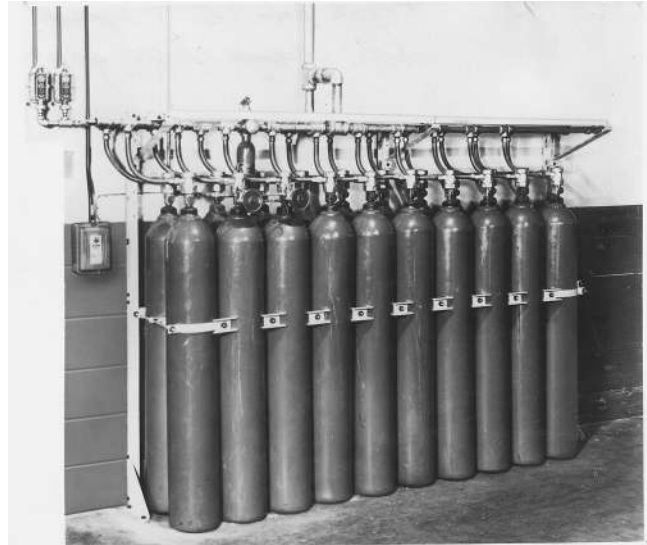
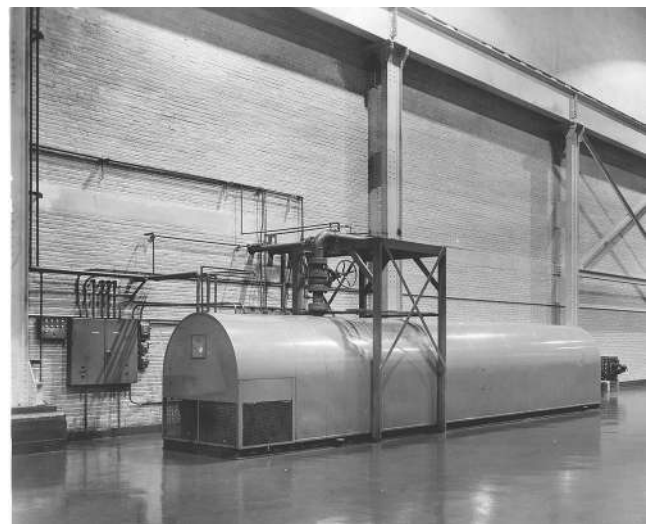

**FIGURE A.4.6.5.2** A Typical High-Pressure Storage Facility.

with an outer metal housing that is sealed to keep out water moisture. A standard air-cooled refrigeration unit is mounted at one end, with its cooling coils mounted within the pressure vessel. This unit is electrically powered and automatically controlled by means of a pressure switch.

**A.4.6.6.2** A special relief valve (in addition to code requirements) can be provided for controlled bleedoff at a pressure below the setting of the main safety valve.

**A.4.7** The specified pipe, fittings, and components have been refined based on field experience through the development of this standard. The calculation methods for wall thickness shown in ASME B31.1, with SE values as stated in mandatory Appendix A of B31.1, are to be applied to pipe and fittings that are not specified in this standard.



**FIGURE A.4.6.6** A Typical Low-Pressure Storage Facility.

**A.4.7.1** Piping should be installed in accordance with good commercial practices and the equipment manufacturer's recommendations.

All piping should be laid out to reduce friction losses to a reasonable minimum, and care should be taken to avoid possible restrictions due to foreign matter or faulty fabrication.

Examples include hot-dipped piping galvanized inside and out or stainless steel piping.

**A.4.7.1.3** The use of flexible piping or hose in a carbon dioxide system introduces a number of considerations that do not affect rigid piping. One of these is the nature of any changes of direction. The minimum radius of curvature for any flexible hose to be used in a carbon dioxide system should not be less than indicated by the manufacturer's data, usually shown in the listing information for a particular system. Other areas of concern are resistance to the effects of vibration, flexure, tension, torsion, temperature, flame, compression, and bending. It is also necessary for the hose to have the strength to contain the carbon dioxide during discharge and to be made of materials that will be resistant to atmospheric corrosion.

▲ **A.4.7.1.7.1** In performing the calculation to determine pipe thickness, the guidelines provided in the *FSSA Pipe Design Handbook for Use with Special Hazard Fire Suppression Systems* should be consulted.

**A.4.7.1.8.1** The FSSA guide referenced in A.4.7.1.7.1 should also be consulted for low-pressure systems.

• **A.4.7.4** The discharge nozzle consists of the orifice and any associated horn, shield, or baffle.

**A.4.7.4.4** Formerly, a plus sign following the orifice code number indicated an equivalent diameter  $\frac{1}{64}$  in. (0.4 mm) greater than that indicated by the numbering system [e.g., No. 4 indicated an equivalent diameter of  $\frac{1}{32}$  in. (3.18 mm); a No. 4+,  $\frac{1}{64}$  in. (3.57 mm)].

**A.4.7.4.4.3** For examples of equivalent orifice diameters, see Table A.4.7.4.4.3. The orifice code numbers indicate the equivalent single-orifice diameter in  $\frac{1}{32}$  in. (0.8 mm) increments.

The codes represent the diameters of “perfect” orifices with performance equivalent to the actual physical nozzle.

By *performance* is meant that the actual nozzle will express the same quantity of CO<sub>2</sub> per unit time as a “perfect” nozzle under the same conditions of CO<sub>2</sub> pressure and density entering the nozzle.

A *perfect orifice* is defined as a rounded entry nozzle with a flow coefficient not less than 0.98 that produces flow rates given in Table 4.7.5.2.1 and Table 4.7.5.3.1.

The physical area of actual discharge nozzles used in CO<sub>2</sub> systems is generally larger than the area of the equivalent perfect orifice to which it is compared.

The following example illustrates the concept of the orifice code number. A single orifice discharge nozzle having a flow coefficient of 0.98 and a diameter of  $\frac{3}{32}$  in. (2.38 mm) will have an orifice code number of 3. But a single orifice discharge nozzle having a flow coefficient of 0.5 and a diameter of  $\frac{3}{32}$  in. (2.38 mm) will have an orifice code number 2.1, not a code number of 3.

**Table A.4.7.4.4.3 Equivalent Orifice Sizes**

Orifice Code No.	Equivalent Single-Orifice Diameter		Equivalent Single-Orifice Area	
	in.	mm	in. <sup>2</sup>	mm <sup>2</sup>
1	$\frac{1}{32}$	0.79	0.0008	0.49
1.5	$\frac{3}{64}$	1.19	0.0017	1.11
2	$\frac{1}{16}$	1.59	0.0031	1.98
2.5	$\frac{3}{64}$	1.98	0.0047	3.09
3	$\frac{3}{32}$	2.38	0.0069	4.45
3.5	$\frac{7}{64}$	2.78	0.0094	6.06
4	$\frac{1}{8}$	3.18	0.0123	7.94
4.5	$\frac{9}{64}$	3.57	0.0155	10.00
5	$\frac{5}{32}$	3.97	0.0192	12.39
5.5	$\frac{11}{64}$	4.37	0.0232	14.97
6	$\frac{3}{16}$	4.76	0.0276	17.81
6.5	$\frac{13}{64}$	5.16	0.0324	20.90
7	$\frac{7}{32}$	5.56	0.0376	24.26
7.5	$\frac{15}{64}$	5.95	0.0431	27.81
8	$\frac{1}{4}$	6.35	0.0491	31.68
8.5	$\frac{17}{64}$	6.75	0.0554	35.74
9	$\frac{9}{32}$	7.14	0.0621	40.06
9.5	$\frac{19}{64}$	7.54	0.0692	44.65
10	$\frac{5}{16}$	7.94	0.0767	49.48
11	$\frac{11}{32}$	8.73	0.0928	59.87
12	$\frac{3}{8}$	9.53	0.1105	71.29
13	$\frac{13}{32}$	10.32	0.1296	83.61
14	$\frac{7}{16}$	11.11	0.1503	96.97
15	$\frac{15}{32}$	11.91	0.1725	111.29
16	$\frac{1}{2}$	12.70	0.1964	126.71
18	$\frac{9}{16}$	14.29	0.2485	160.32
20	$\frac{5}{8}$	15.88	0.3068	197.94
22	$\frac{11}{16}$	17.46	0.3712	239.48
24	$\frac{3}{4}$	19.05	0.4418	285.03
32	1	25.40	0.785	506.45
48	1½	38.40	1.765	1138.71
64	2	50.80	3.14	2025.80

**A.4.7.5.1** For further explanation for determining pressure drop in the pipeline, see Annex C.

■ **A.4.7.6** The *FSSA Pipe Design Handbook for Use with Special Hazard Fire Suppression Systems* provides guidance on pipe hangers and supports, following established industry practices. Additional guidance based on “best industry standard practice” is found in ANSI/MSS SP-58 for locations where seismic qualification is not required or in MSS SP-127 for locations where seismic qualification is required.

**A.4.8** See A.4.4.3.

**A.4.8.1** An inspection of the system is a quick check to give reasonable assurance that the extinguishing system is fully charged and operable. It is done by seeing that the system is in place, that it has not been actuated or tampered with, and that there is no obvious physical damage or condition to prevent operation. As a minimum, the inspection should determine the following:

- (1) High-pressure cylinders are in place and properly secured.

- (2) For a low-pressure storage unit, the pressure gauge shows normal pressure, that the tank shutoff valve is open, and that the pilot pressure supply valve is open. The liquid level gauge should be observed. If at any time a container shows a loss of more than 10 percent, it should be refilled, unless the minimum gas requirements are still provided.
  - (3) Carbon dioxide storage is connected to discharge piping and actuators.
  - (4) All manual actuators are in place and tamper seals are intact.
  - (5) Nozzles are connected, properly aligned, and free from obstructions and foreign matter.
  - (6) Detectors are in place and free from foreign matter and obstructions.
  - (7) The system control panel is connected and showing "normal-ready" condition.
- A.4.8.3** The manufacturer's maintenance procedure should be guided by the following outline:
- (1) System
    - (a) Check overall physical appearance.
    - (b) Disarm system prior to test.
  - (2) Hazard
    - (a) Check size.
    - (b) Check configuration.
    - (c) Check uncloseable openings.
    - (d) Check fuels.
    - (e) Check other aspects that could affect effectiveness of the extinguishing systems.
  - (3) Supervised circuits
    - (a) Exercise all functions.
    - (b) Check all electrical or pneumatic supervisory circuits for proper operation.
  - (4) Control panel
    - (a) Exercise all functions.
    - (b) Check supervision, if applicable, of each circuit (including releasing devices) as recommended by the manufacturer.
  - (5) Power supply — check routing, circuit breakers, fuses, disconnects.
  - (6) Emergency power
    - (a) Check battery condition.
    - (b) Check charger operation; check fuse.
    - (c) Check automatic changeover.
    - (d) Check maintenance of generator (if one exists).
  - (7) Detectors
    - (a) Test each detector using heat, smoke, or manufacturer's approved test device.
    - (b) Electric type
      - i. Clean and adjust smoke detector and check sensitivity.
      - ii. Check wiring condition.
    - (c) Pneumatic type — check tightness of tubing and operation of mercury checks, using manometer.
  - (8) Time delay
    - (a) Exercise functions.
    - (b) Check time limit.
    - (c) Check that timer will complete its cycle even if wiring between it and the detector circuit is interrupted.
  - (9) Alarms
    - (a) Test for operation (audible and visible).
    - (b) Check that warning signs are properly displayed.
  - (10) Selector (directional) valves
    - (a) Exercise functions.
    - (b) Reset properly.
  - (11) Release devices
    - (a) Check for complete closure of dampers.
    - (b) Check doors; check for any doors that are blocked open.
  - (12) Equipment shutdown
    - (a) Test shutdown function.
    - (b) Check adequacy (all necessary equipment included).
  - (13) Manual releases
    - (a) Mechanical type
      - i. Check pull, force, and length of pull required.
      - ii. Operate and adjust all devices.
      - iii. Check tightness of connectors.
      - iv. Check condition of conduit.
      - v. Check condition and operation of corner pulleys.
    - (b) Electric type
      - i. Test manual release.
      - ii. Check that covers are in place.
    - (c) Check pneumatic releases.
    - (d) Check accessibility during fire.
    - (e) Separate main and reserve manual pulls that require only one operation, to obtain discharge of either main or reserve supply of gas.
    - (f) Clearly mark and identify all manual releases.
  - (14) Piping
    - (a) Check security; check that piping is adequately supported.
    - (b) Check condition; check for any corrosion.
  - (15) Nozzles
    - (a) Check orientation and orifice size; make sure they are unchanged from original design.
    - (b) Check security.
    - (c) Check seals where needed.
    - (d) Ensure orifice of nozzle is free of rust, debris (i.e., bugs, spider webs), and so forth, and clean/repair/replace if necessary.
  - (16) Containers
    - (a) Check physical condition; check for any sign of corrosion.
    - (b) Check the contents for weight by acceptable methods for each cylinder or low-pressure tank. (If the contents are more than 10 percent below the normal capacity, refilling is required. Proper operation of the liquid level gauge should be verified.)
    - (c) Check that cylinders are securely held in position.
    - (d) Check hydrostatic test date.
    - (e) Check cylinder connectors for integrity and condition.
    - (f) Check weights and cables of mechanical release system.
    - (g) Release devices; check for proper arrangement and security.



- (h) Check explosive release devices; check replacement date and check condition.
- (17) Tests
  - (a) Perform recommended discharge tests if there are any questions about the adequacy of the system.
  - (b) Perform recommended full discharge test if cylinder hydrostatic test is required.
- (18) Return all parts of system to full service.
- (19) Give certificate of inspection to owner.

Regular service contracts with the manufacturer or installing company are recommended. Work should be performed by personnel thoroughly trained and regularly engaged in providing such services.

▲ **A.4.8.3.3** The maintenance report provides the owner with valuable information pertaining to the fire system, its condition, and recommendations. The servicing company should review its maintenance report to ensure that it captures the necessary data and performs the maintenance in a thorough and safe manner. The **FSSA Fire Protection Systems Inspection Form Guidelines** can be used to evaluate the service company's maintenance report.

**A.4.8.3.4** The method of sealing should not introduce any new hazards.

**A.4.8.4** Persons who inspect, test, or maintain carbon dioxide systems should be trained and periodically tested for competence in the functions they perform. Attending training programs offered by equipment manufacturers and other training organizations should be considered.

**A.5.1.2** Achieving and maintaining the right concentration ensures the complete and permanent extinguishment of the fire in the specific combustible material or materials involved.

**A.5.2.1** Under this class of protection, a reasonably well-enclosed space is assumed in order to minimize the loss of the extinguishing medium. The area of allowable unclosable openings depends on the type of combustibles involved.

**A.5.2.1.1** Where two or more hazards by reason of their proximity are expected to be simultaneously involved in fire, each hazard should be protected with an individual system, protected with the combination arranged to operate simultaneously, or protected with a single system that should be sized and arranged to discharge on all potentially involved hazards simultaneously.

**A.5.2.1.3** For deep-seated fires, low-level openings should be avoided regardless of the relief requirements in order to maintain a concentration for as long as necessary. Relief vents under these conditions should be as high within the enclosure as possible.

**A.5.2.3** Practically all hazards that contain materials that produce surface fires can contain varying amounts of materials that could produce deep-seated fires. Proper selection of the type of fire that the system should be designed to extinguish is important and, in many cases, requires sound judgment after careful consideration of all the various factors involved.

Basically, such a decision is based on the answers to the following questions:

- (1) Will a deep-seated fire develop, considering the speed of detection and application of the contemplated system?

- (2) If a deep-seated fire does develop, will it be of a minor nature, will the circumstances be such that it will not cause a reflash of the material that produced the surface fire, and can arrangements be set up to put it out manually after the carbon dioxide discharge before it causes trouble?
- (3) Are the values involved or the importance of equipment involved such that the ultimate protection is justified regardless of the extra cost of providing a system that will extinguish deep-seated fires?

It will be seen that, with a remote possibility of a deep-seated fire causing trouble, there are many cases where taking this remote risk can be justified, and a system to extinguish surface fires can properly be selected. As an example, electrical transformers and other oil-filled electrical equipment have commonly been treated as producing surface fires, although there could be a chance that a heated core will produce a deep-seated fire in electrical insulation. On the other hand, the importance of some of the electrical equipment to production can be such that treating the hazard as a deep-seated fire will be justified.

Often a decision involves consultation with the authority having jurisdiction and with the owner and the engineers of the company supplying the equipment. The cost comparison between a system designed to extinguish a surface fire and one designed to extinguish a deep-seated fire can be the deciding factor. In all cases, it is advisable that all interested parties are fully aware of any risks involved if the system is designed to extinguish only a surface fire and of the additional costs involved if a system is designed to extinguish a deep-seated fire.

**A.5.2.3.1** Surface fires are the most common hazard particularly adaptable to extinguishment by total flooding systems.

**A.5.2.3.2** In any event, it is necessary to inspect the hazard immediately after a deep-seated fire to make certain that extinguishment is complete and to remove any material involved in the fire.

**A.5.3.2.2** The theoretical minimum carbon dioxide concentration and the minimum design carbon dioxide concentration to prevent ignition of some common liquids and gases are given in Table 5.3.2.2.

**A.5.3.3.1** Because the average small space has proportionately more boundary area per enclosed volume than a larger space, greater proportionate leakages are anticipated and accounted for by the graded volume factors in Table 5.3.3(a) and Table 5.3.3(b).

The least gas quantities for the smallest volumes are tabulated in order to clarify the intent of column B in Table 5.3.3(a) and Table 5.3.3(b) and thus avoid possible overlapping at borderline volumes.

**A.5.3.5.1** Where forced ventilation is not a consideration, leakage of a carbon dioxide-air mixture from an enclosed space depends on one or more of the following parameters:

- (1) *Temperature of Enclosure.* Carbon dioxide will not expand as much at a low temperature and will be more dense; thus, a greater amount will leak out if the openings are in the lower portion of the enclosure.



- (2) *Volume of Enclosure.* The percent of total volume of carbon dioxide lost through any given opening in a small enclosure will be much greater than that from the same opening in a large enclosure.
- (3) *Venting.* An opening at or near the ceiling is usually desirable to permit exhausting the lighter gases from the room during the discharge.
- (4) *Location of Openings.* Because carbon dioxide is heavier than air, there could be little or no loss of carbon dioxide from openings near the ceiling, while the loss at the floor level could be substantial.

**A.5.3.5.3** Hazards located in enclosures that are normally at temperatures above 200°F (93°C) can be more susceptible to re-ignition. Therefore, additional carbon dioxide is advisable to hold the extinguishing concentrations for a longer period of time, allowing the extinguished material to cool down and thereby reduce the chances of re-ignition when the gas dissipates.

**A.5.3.5.5** Under normal conditions, surface fires are usually extinguished during the discharge period.

**A.5.3.5.7** Testing has shown that carbon dioxide applied directly to the liquid surface by local application-type nozzles can be necessary to provide the required cooling to prevent re-ignition after the end of the carbon dioxide discharge.

**A.5.4.1** Although specific test data are lacking, it is recognized that certain types of deep-seated fires can require holding times in excess of 20 minutes. The quantity of carbon dioxide for deep-seated-type fires is based on fairly tight enclosures.

**A.5.4.2** For combustible materials capable of producing deep-seated fires, the required carbon dioxide concentrations cannot be determined with the same accuracy possible with surface-burning materials. The extinguishing concentration will vary with the mass of material present because of the thermal insulating effects. Flooding factors have therefore been determined on the basis of practical test conditions.

**A.5.4.2.1** Generally, the flooding factors have been found to provide proper design concentrations for the rooms and enclosures listed in Table 5.4.2.1.

For further information, see Annex D.

Depending on combustibility, these hazards might not involve deep-seated fires. (See 5.3.5.6.)

**A.5.5.2** The minimum design rates of application established are considered adequate for the usual surface or deep-seated fire. However, where the spread of fire can be faster than normal for the type of fire, or where high values or vital machinery or equipment are involved, rates higher than the minimums can, and in many cases should, be used. Where a hazard contains material that will produce both surface and deep-seated fires, the rate of application should be at least the minimum required for surface fires. Having selected a rate suitable to the hazard, the tables and information that follow should be used or such special engineering as is required should be carried out to obtain the proper combination of container releases, supply piping, and orifice sizes that will produce this desired rate.

The leakage rate from an enclosure in the absence of forced ventilation depends mainly on the difference in density between the atmosphere within the enclosure and the air surrounding the enclosure. The following equation can be

used to calculate the rate of carbon dioxide loss, assuming that there is sufficient leakage in the upper part of the enclosure to allow free ingress of air:

[A.5.5.2]

$$R = 60C\rho A \sqrt{\frac{2g(\rho_1 - \rho_2)h}{\rho_1}}$$

where:

$R$  = rate of CO<sub>2</sub> [lb/min (kg/min)]

$C$  = CO<sub>2</sub> concentration fraction

$\rho$  = density of CO<sub>2</sub> vapor [lb/ft<sup>3</sup> (kg/m<sup>3</sup>)]

$A$  = area of opening [ft<sup>2</sup> (m<sup>2</sup>) (flow coefficient included)]\*

$g$  = gravitational constant [32.2 ft/sec<sup>2</sup> (9.81 m/sec<sup>2</sup>)]

$\rho_1$  = density of atmosphere [lb/ft<sup>3</sup> (kg/m<sup>3</sup>)]

$\rho_2$  = density of surrounding air [lb/ft<sup>3</sup> (kg/m<sup>3</sup>)]

$h$  = static head between opening and top of enclosure [ft (m)]

\*If there are openings in the walls only, the area of the wall openings can be divided by 2 for calculations because it is presumed that fresh air can enter through one-half of the openings and that protective gas will exit through the other half.

Figure E.1(b) can be used as a guide in estimating discharge rates for extended discharge systems. The curves were calculated using the preceding equation, assuming a temperature of 70°F (21°C) inside and outside the enclosure. In an actual system, the inside temperature will normally be reduced by the discharge, thus increasing the rate of loss. Because of the many variables involved, a test of the installed system could be needed to ensure proper performance.

Where leakage is appreciable, the design concentration should be obtained quickly and maintained for an extended period of time. Carbon dioxide provided for leakage compensation should be applied at a reduced rate. The extended rate of discharge should be sufficient to maintain the minimum concentration.

**A.5.5.2.1** Normally, the measured discharge time is considered to be the time when the measuring device starts to record the presence of carbon dioxide until the design concentration is achieved.

**A.5.5.3** For enclosed recirculating-type electrical equipment, the initial discharge quantity should not be less than 1 lb (0.45 kg) of gas for each 10 ft<sup>3</sup> (0.28 m<sup>3</sup>) of enclosed volume up to 2000 ft<sup>3</sup> (56.6 m<sup>3</sup>). For larger volumes, 1 lb (0.45 kg) of gas for each 12 ft<sup>3</sup> (0.34 m<sup>3</sup>) or a minimum of 200 lb (90.8 kg) should be used. Table A.5.5.3(a) and Table A.5.5.3(b) can be used as a guide to estimate the quantity of gas needed for the extended discharge to maintain a minimum concentration of 30 percent for the deceleration time. The quantity is based on the internal volume of the machine and the deceleration time, assuming average leakage. For damped, non-recirculating-type machines, add 35 percent to the indicated quantities in Table A.5.5.3(a) and Table A.5.5.3(b) for extended discharge protection.

**A.5.5.4.2** Methods available to compensate for temperature exposures include reduced filling density for high temperatures and nitrogen super-pressurization combined with

**Table A.5.5.3(a) Extended Discharge Protection for Enclosed Recirculating Rotating Electrical Equipment (Cubic Feet Protected for Deceleration Time)**

lb CO <sub>2</sub>	Time (minutes)							
	5	10	15	20	30	40	50	60
100	1,200	1,000	800	600	500	400	300	200
150	1,800	1,500	1,200	1,000	750	600	500	400
200	2,400	1,950	1,600	1,300	1,000	850	650	500
250	3,300	2,450	2,000	1,650	1,300	1,050	800	600
300	4,600	3,100	2,400	2,000	1,650	1,300	1,000	700
350	6,100	4,100	3,000	2,500	2,000	1,650	1,200	900
400	7,700	5,400	3,800	3,150	2,500	2,000	1,600	1,200
450	9,250	6,800	4,900	4,000	3,100	2,600	2,100	1,600
500	10,800	8,100	6,100	5,000	3,900	3,300	2,800	2,200
550	12,300	9,500	7,400	6,100	4,900	4,200	3,600	3,100
600	13,900	10,900	8,600	7,200	6,000	5,200	4,500	3,900
650	15,400	12,300	9,850	8,300	7,050	6,200	5,500	4,800
700	16,900	13,600	11,100	9,400	8,100	7,200	6,400	5,600
750	18,500	15,000	12,350	10,500	9,150	8,200	7,300	6,500
800	20,000	16,400	13,600	11,600	10,200	9,200	8,200	7,300
850	21,500	17,750	14,850	12,700	11,300	10,200	9,100	8,100
900	23,000	19,100	16,100	13,800	12,350	11,200	10,050	9,000
950	24,600	20,500	17,350	14,900	13,400	12,200	11,000	9,800
1,000	26,100	21,900	18,600	16,000	14,500	13,200	11,900	10,700
1,050	27,600	23,300	19,900	17,100	15,600	14,200	12,850	11,500
1,100	29,100	24,600	21,050	18,200	16,600	15,200	13,750	12,400
1,150	30,600	26,000	22,300	19,300	17,700	16,200	14,700	13,200
1,200	32,200	27,300	23,550	20,400	18,800	17,200	15,600	14,100
1,250	33,700	28,700	24,800	21,500	19,850	18,200	16,500	14,900
1,300	35,300	30,100	26,050	22,650	20,900	19,200	17,450	15,800
1,350	36,800	31,400	27,300	23,750	22,000	20,200	18,400	16,650
1,400	38,400	32,800	28,550	24,900	23,100	21,200	19,350	17,500
1,450	39,900	34,200	29,800	26,000	24,200	22,200	20,300	18,350
1,500	41,400	35,600	31,050	27,100	25,250	23,200	21,200	19,200

reduced filling density for low temperatures. Manufacturers should be consulted for advice.

**A.5.6.1** The pressure venting consideration involves such variables as enclosure strength and injection rate.

**A.5.6.2** Porosity and leakages such as at doors, windows, and dampers, although not readily apparent or easily calculated, have been found to provide sufficient relief for the normal carbon dioxide flooding systems without need for additional venting. Record storage rooms, refrigerated spaces, and ductwork have also been found to need no additional venting when tested under their average system conditions.

In many instances, particularly when hazardous materials are involved, relief openings are already provided for explosion venting. These and other available openings often provide adequate venting.

General construction practices provide the guide in Table A.5.6.2 for considering the normal strength and allowable pressures of average enclosures.

**A.6.1.2** Examples of hazards that are protected by local application systems include dip tanks, quench tanks, spray booths, oil-filled electric transformers, vapor vents, rolling mills, printing presses, and so forth.

**A.6.1.4** Reference is made to Section 4.3, 4.5.5, and A.4.3 regarding hazards to personnel due to obscuration of vision

and reduction of oxygen concentration below that which will support life, not only in the immediate area of discharge, but in adjacent areas to which gas can migrate.

**A.6.3.1** In computing the total quantity of carbon dioxide required for a local application system, the flow rates for all nozzles should be added together to obtain the mass flow rate for protection of the particular hazard. This rate should be multiplied by the discharge time.

**A.6.3.1.1** These cylinders are normally rated in nominal capacities of 50 lb, 75 lb, and 100 lb (22.7 kg, 34.1 kg, and 45.4 kg) of carbon dioxide. When the cylinders are filled with carbon dioxide at a normal filling density not in excess of 68 percent, a portion of the discharge from the cylinders will be as liquid carbon dioxide and the remainder will be as vapor. For design purposes, the vapor discharge is considered to be ineffective in extinguishing a fire. It has been found that the amount of carbon dioxide discharged from the nozzle as liquid carbon dioxide varies from 70 percent to 75 percent of the total quantity of carbon dioxide contained in the cylinder, and thus it is necessary to increase the nominal cylinder capacity for a given system by 40 percent to account for the vapor portion of the carbon dioxide. For example, a 50 lb (22.7 kg) cylinder can be expected to discharge between 35 lb and 37.5 lb (15.9 kg and 17.0 kg) of carbon dioxide as liquid that is the part of the discharge that is effective in fire extinguishment.

**Table A.5.5.3(b) Extended Discharge for Enclosed Recirculating Rotating Electrical Equipment (Cubic Meters Protected for Deceleration Time) (SI Units)**

kg CO <sub>2</sub>	Time (minutes)							
	5	10	15	20	30	40	50	60
45.4	34.0	28.3	22.6	17.0	14.2	11.3	8.5	5.7
68.1	50.9	42.5	34.0	28.3	21.2	17.0	14.0	11.3
90.8	67.9	55.2	45.3	36.8	28.3	24.1	18.4	14.2
113.5	93.4	69.3	56.6	46.7	36.8	29.7	22.6	17.0
136.2	130.2	87.7	67.9	56.6	46.7	36.8	28.3	19.8
158.9	172.6	116.0	84.9	70.8	56.6	46.7	34.0	25.5
181.6	217.9	152.8	107.5	89.1	70.8	56.6	45.3	34.0
204.3	261.8	192.4	138.7	113.2	87.7	73.6	59.4	45.3
227.0	305.6	229.2	172.6	141.5	110.4	93.4	79.2	62.3
249.7	348.1	268.9	209.4	172.6	138.7	118.9	101.9	87.7
272.4	393.4	308.5	243.4	203.8	169.8	147.2	127.4	110.4
295.1	435.8	348.1	278.8	234.9	199.5	175.5	155.7	135.8
317.8	478.3	384.9	314.1	266.0	229.2	203.8	181.1	158.5
340.5	523.6	424.5	349.5	297.2	258.9	232.1	206.6	184.0
363.2	586.0	464.1	384.9	328.3	288.7	260.4	232.1	206.6
385.9	608.4	502.3	420.3	359.4	319.8	288.7	257.5	229.2
408.6	650.9	540.5	455.6	390.5	349.5	317.0	284.4	254.7
431.3	696.2	580.2	491.0	421.7	379.2	345.3	311.3	277.3
454.0	738.6	619.8	526.4	452.8	410.4	373.6	336.8	302.8
476.7	781.1	659.4	563.2	483.9	441.5	401.9	363.7	325.5
499.4	823.5	696.2	595.7	515.1	469.8	430.2	389.1	350.9
522.1	866.0	735.8	631.1	546.2	500.9	458.5	416.0	373.6
544.8	911.3	772.6	666.5	577.3	532.0	486.8	441.5	399.0
567.5	953.7	812.2	701.8	609.4	561.8	515.1	467.0	421.7
590.2	999.0	851.8	737.2	641.0	591.5	543.4	493.8	447.1
612.9	1041.4	888.6	772.6	672.1	622.6	571.7	520.7	471.2
635.6	1086.7	928.2	808.0	704.7	653.7	600.0	547.6	495.3
658.3	1129.2	967.9	843.3	735.8	684.9	628.3	574.5	519.3
681.0	1171.6	1007.5	878.7	766.9	713.2	656.6	600.0	543.4

**A.6.3.1.2** When liquid carbon dioxide flows through a warm pipeline, the liquid evaporates rapidly until the pipeline is cooled to the saturation temperature of the carbon dioxide. The quantity of carbon dioxide liquid evaporated in this manner depends on the total amount of heat that should be removed from the pipeline and the latent heat of evaporation of the carbon dioxide. For high-pressure carbon dioxide, the latent heat of evaporation is about 64 Btu/lb (149 kJ/kg); for low-pressure carbon dioxide, the latent heat of evaporation is about 120 Btu/lb (279 kJ/kg).

The quantity of heat to be removed from the pipeline is the product of the weight of the pipeline times the specific heat of the metal times the average temperature change of the pipeline. For steel pipe, the average specific heat is about 0.11 Btu/lb·°F (0.46 kJ/kg·K) temperature change. The average temperature change will be the difference between the temperature at the beginning of the discharge and the average temperature of the liquid flowing through the pipe. For high-pressure carbon dioxide, the average temperature of the liquid in the pipeline can be assumed to be about 60°F (16°C). For low-pressure carbon dioxide, the average temperature can be assumed to be about -5°F (-21°C). These temperatures would of course vary somewhat in accordance with average nozzle pressures; however, such minor adjustments would not substantially affect the results. The following equation can be used to compute the quantity of carbon dioxide evaporated in the pipeline:

**Table A.5.6.2 Strength and Allowable Pressures for Average Enclosures**

Type Construction	Windage (mph)	Pressure (lb/ft <sup>2</sup> )	Water		
			in.	psi	kPa
Light building	100	25*	5	0.175	1.2
Normal building	140	50†	10	0.35	2.4
Vault building	200	100	20	0.70	4.8

\*Venting sash remains closed.

†Venting sash designed to open freely.

[A.6.3.1.2]

$$W = \frac{wC_p(T_1 - T_2)}{H}$$

where:

W = CO<sub>2</sub> evaporated [lb (kg)]

w = weight of piping [lb (kg)]

C<sub>p</sub> = specific heat of metal in pipe [Btu/lb·°F; 0.11 for steel (kJ/kg·K; 0.46 for steel)]

T<sub>1</sub> = average pipe temperature before discharge [°F (°C)]

$T_2$  = average CO<sub>2</sub> temperature [°F (°C)]

$H$  = latent heat of evaporation of liquid CO<sub>2</sub> [Btu/lb (kJ/kg)]

**A.6.3.3** Because the tests conducted in the listing or approvals of carbon dioxide nozzles require that fires be extinguished within a maximum time limit of 20 seconds, a minimum duration of 30 seconds has been established for this standard. This extra time allows a factor of safety for conditions that can be unpredictable. It is important to recognize that this discharge time is a minimum and that conditions such as high temperatures and cooling of unusually hot surfaces within the hazard area can require an increase in the discharge time to ensure complete and effective extinguishment.

**A.6.3.3.2** The flow of carbon dioxide need not start nor stop simultaneously at all nozzles, but all nozzles must discharge liquid carbon dioxide simultaneously for at least the minimum liquid discharge time.

**A.6.3.3.5** The maximum temperature of a burning liquid fuel is limited by its boiling point where evaporative cooling matches the heat input. In most liquids, the auto-ignition temperature is far above the boiling temperature, so that re-ignition after extinguishment can be caused only by an external ignition source. However, a few unique liquids have auto-ignition temperatures that are much lower than their boiling temperatures. Common cooking oils and melted paraffin wax have this property. To prevent re-ignition in these materials, it is necessary to maintain an extinguishing atmosphere until the fuel has cooled below its auto-ignition temperature. A discharge time of 3 minutes is adequate for small units, but a longer time could be needed for larger-capacity units.

**A.6.4.1** The practical application of the rate-by-area method is explained in the *FSSA Design Guidelines for Carbon Dioxide Local Application Rate-by-Area*. The guide assists the user through the entire process of a rate-by-area CO<sub>2</sub> system design with examples. The user will gain an understanding of the steps involved with the layout, calculation, and overall design of the system.

**A.6.4.2.1** In the individual listings or approvals of overhead-type nozzles, tests are conducted to determine the optimum design flow rate at which a nozzle should be used for the height at which it is installed above a liquid surface. The tests are conducted in the following manner:

- (1) Fire tests of overhead-type nozzles are conducted to develop a curve relating maximum flow rates at which a nozzle can be used at various heights. Testing at a number of heights establishes a splash curve, which can be plotted as a straight-line function of height versus flow rate. In conducting these tests, the flow rates used are computed on the basis of high-pressure storage conditions of 70°F (21°C) [average pressure 750 psi (5171 kPa)] and low-pressure storage conditions of 0°F (-18°C) [300 psi (2068 kPa)]. In the case of high-pressure tests, the fire tests are conducted with the cylinders conditioned at a temperature of 120°F (49°C), which gives a flow rate somewhat higher than the computed flow rate.
- (2) Following A.6.4.2.1(1), a minimum flow rate for various heights is assumed at a computed flow rate that is 75 percent of the maximum flow rate previously established. Again, a straight-line curve of flow rate versus height can be plotted.
- (3) Following A.6.4.2.1(2), tests are conducted in which the area of the fire is varied to determine the maximum area

that can be extinguished by a particular nozzle at various heights when applied at a flow rate equal to 75 percent of the maximum flow rate. In conducting these tests for high-pressure storage cylinders, the flow rates for the various fires are computed on the basis of 70°F (21°C) storage temperature [750 psi (5171 kPa)], and the test cylinders are conditioned to a temperature of 32°F (0°C).

- (4) From the data from A.6.4.2.1(1) through A.6.4.2.1(3), two curves are plotted. The first is a flow rate versus height curve, and the second is an area versus height curve. The final plot of the flow rate versus height curve shows a single curve established at a flow rate that is 90 percent of the maximum flow rate. It is then possible to utilize this nozzle for various heights at the design flow rate indicated by this curve or at flow rates slightly above or below this curve to allow for differences between computed and actual rates. Typical curves are shown in Figure D.1(a) and Figure D.1(b).

Because these curves are developed on the basis of fire tests utilizing square pans, it is important to remember that the area coverage for nozzles at various heights shown by the second curve should be on the basis of approximate square areas. It is also important to remember that these two curves represent the limitations of single-nozzle coverage.

In multiple-nozzle systems, these limitations are used for the portion of a hazard covered by each individual nozzle.

**A.6.4.2.2** For tankside and linear nozzles, fire tests are conducted to develop curves relating the maximum and minimum flow rates at which a nozzle can be used to the area of fire that the nozzle is capable of extinguishing, with additional limitations regarding maximum width of hazard and spacing requirements between nozzles and to the nearest corner of a hazard. In these tests, the nozzles are normally installed at a distance of 6 in. (152 mm) above the liquid surface, thereby eliminating the parameter of height. These tests are conducted in the following manner.

Single or multiple nozzles are mounted on the edge of square or rectangular pans. In the multiple-nozzle tests, nozzles are mounted on one side or on two opposing sides. Tests are conducted on a number of pan sizes with various spacing arrangements to establish a maximum rate or splash curve, which can be plotted as a function of flow rate versus area covered or hazard width. Following this step, the minimum flow rate for various area or hazard width conditions (with other appropriate spacing limitations) is determined by a similar series of tests.

For all of these tests, the flow rates are calculated on the basis of 0°F (-18°C) storage temperature for low-pressure systems [average pressure 300 psi (2068 kPa)] or 70°F (21°C) storage temperature for high-pressure systems [average pressure 750 psi (5171 kPa)]. In high-pressure systems, the actual storage temperature can vary between 120°F (49°C) and 32°F (0°C). For this reason, the maximum rate or splash rate tests are conducted using storage cylinders conditioned to 120°F (49°C), which gives a flow rate somewhat higher than the computed rate. The minimum rate tests are conducted using storage cylinders conditioned to 32°F (0°C), which gives a flow rate somewhat lower than the computed rate.

From the data developed from these tests, a plot of flow rate versus area coverage or hazard width is made with the maximum or splash curve reduced by a factor of 10 percent and the



minimum rate increased by a factor of 15 percent. A typical curve for a tankside nozzle is shown by Figure F.1(c), and a curve for a linear nozzle is shown by Figure F.1(d).

**A.6.4.3.4** For listing and approval testing, overhead local application carbon dioxide nozzles are tested on two-dimensional pan fires. (See A.6.4.2.1.) Some nozzles have excellent area of coverage when used on such “flat” fires. Although the actual cone of discharge can directly impinge on only a small area of the fire, the carbon dioxide can flow away from the actual area of impact and effectively cover a much larger area of the fire pan.

If the surface on which the carbon dioxide discharge impinges is very irregular, it is possible that the nozzle discharge could not effectively cover all parts of the hazard. If the nozzles being used have small areas of impact compared to their listed areas of coverage, additional nozzles could be necessary to completely cover irregularly shaped objects. Where such irregularly shaped hazards are to be covered, the designer should be certain that the number, type, and location of nozzles are sufficient to ensure complete coverage of the hazard surfaces. Verifying the coverage of local application nozzles is an important part of the discharge test.

**A.6.4.4.5** Additional nozzles can be required for this specific purpose, particularly if stock extends more than 2 ft (0.6 m) above a protected surface.

**Δ A.6.5.1** The practical application of the rate-by-volume method is complicated. The design of a system can be aided by examples and a walk-through calculation of a system. The FSSA *Design Guidelines for Carbon Dioxide Local Application Rate-by-Volume* describes how to design a carbon dioxide system using the rate-by-volume method.

**A.6.5.3.2** Figure A.6.5.3.2 is a graph of the partial enclosure.

**A.6.6.2** High-pressure storage temperatures ranging from 32°F to 120°F (0°C to 49°C) do not require special methods of compensating for changing flow rates.

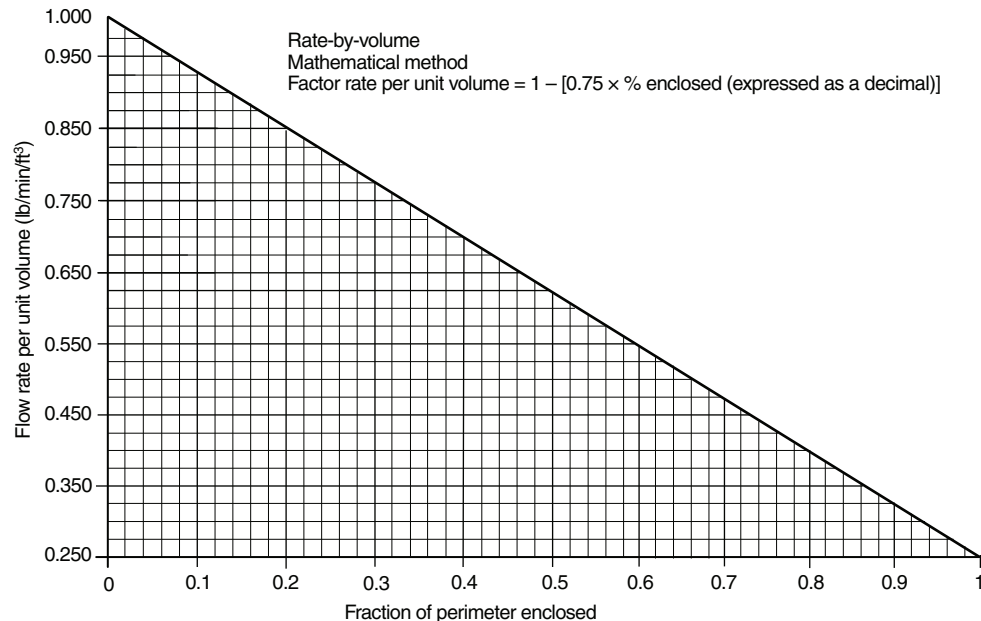

**FIGURE A.6.5.3.2** Partial Enclosure Flow Rate Reduction per 6.5.3.2.

Where high-pressure storage temperatures can fall below 32°F (0°C) or rise above 120°F (49°C), it could be necessary to incorporate special features in the system to ensure proper flow rates.

**A.7.1.1** A separate carbon dioxide supply can be provided for hand hose line use, or carbon dioxide can be piped from a central storage unit supplying several hose lines or from fixed manual or automatic systems. (See 4.6.1.1.)

**A.7.1.4** Reference is made to 4.3.1 and A.4.3 regarding hazards to personnel due to obscuration of vision and reduction of oxygen concentration below that which will support life, not only in the immediate area of discharge but in adjacent areas to which gas can migrate.

**A.7.5.2** The attachment of the discharge nozzle assembly to the hose by means of a swivel connection is desirable for providing more ease of manipulation.

**A.7.5.4** Operation of hand hose line systems depends upon manual actuation and manual manipulation of a discharge nozzle. Speed and simplicity of operation are therefore essential for successful extinguishment.

**A.7.5.4.2** Bleeder valves or similar devices can be utilized to reduce delay in obtaining liquid discharge on low-pressure systems.

**A.8.1.1** The carbon dioxide supply is mounted on a mobile vehicle that can be towed or driven to the scene of a fire and quickly coupled to the standpipe system protecting the involved hazard. Mobile supply is primarily fire brigade or fire department equipment requiring trained personnel for effective use.

**A.8.1.2** Standpipe systems and mobile supply can be used to supplement complete fixed fire protection systems or can be used alone for the protection of the specific hazards as follows:

- (1) Mobile supply can be used as a reserve to supplement a fixed supply.

(2) Mobile supply can also be outfitted with hand hose lines for the protection of scattered hazards.

**A.8.4.1** Extra quantities of carbon dioxide could be required to compensate for delays in getting the mobile supply to the hazard.

**A.8.5** The effectiveness of fire protection provided by stand-pipe systems and mobile supply depends on the efficiency and ability of the manpower that handles the mobile supply. Generally, this equipment is in the category of fire brigade or fire department equipment requiring a regularly assigned crew.

**A.9.1(2)(c)** Examples include spaces containing engines used for propulsion, engines that drive electrical generators, oil filling stations, cargo pumps, or heating, ventilation, and air-conditioning machinery.

**A.9.1(2)(d)** Carbon dioxide systems are not recommended for vehicle spaces that are accessible to passengers.

**A.9.2.1** It is intended that NFPA 12, including this chapter, would be used as a stand-alone document for the design, installation, and maintenance of marine carbon dioxide systems. Chapter 9 was added in 1998 to address marine installations. It was intended to be used in lieu of other standards such as 46 CFR 119, "Machinery Installations."

**A.9.3.3.1** Some internal combustion propulsion engines and generator prime movers draw combustion air from the protected space in which they are installed. Because these types of engines are required to be shut down prior to system discharge, an automatically discharged system in some cases could shut down propulsion or electricity supply when needed most. A nonautomatic system gives the ship's crew the flexibility to decide the best course of action. For example, while navigating in a high-density shipping channel, a ship's ability to maneuver can be more important than immediate system discharge.

**A.9.3.3.2** On offshore platforms and on some vessels, small machinery enclosures are often located such that access by personnel at the time of a fire would be difficult and/or dangerous and cause unacceptable delay in system actuation. As long as life safety and vessel navigability are not adversely impacted, automatic actuation of systems protecting such spaces is permissible.

**A.9.3.3.4** Except for very small protected spaces noted in 9.3.3.3.3, it is the intent of this standard to require two separate manual operations to cause discharge of a marine system. Provision of a separate manually actuated control for each of the discharge control valves required by 9.3.3.3 accomplishes this intent. This requirement is an exception to the "normal manual operation" as defined in 4.5.1.2.

**A.9.3.3.5** For a high-pressure carbon dioxide system, the emergency manual control for the supply is the manual operator on the pilot cylinder(s).

**A.9.3.3.7** Sufficient carbon dioxide should be provided to power the alarms at their rated pressure for the required time.

**A.9.3.6.2.2** An example of where drains would be necessary would be low points in carbon dioxide piping, which are also used by a sampling-type smoke detection system.

Fires in cargo spaces may not be completely extinguished by the carbon dioxide discharge. Whether the fire is completely

extinguished or only suppressed depends on a number of factors, including the type and quantity of burning material. Some leakage of carbon dioxide-enriched atmosphere from the cargo hold is likely. Therefore, additional carbon dioxide might need to be discharged on an intermittent basis to maintain fire suppression in the cargo hold until the vessel reaches port. Once at port, before the cargo hold is opened, a properly equipped and trained fire brigade should be standing by to effect complete extinguishment of the burning material.

## Annex B Examples of Hazard Protection

*This annex is not a part of the requirements of this NFPA document but is included for informational purposes only.*

**B.1 Introduction.** The following annex material is provided to show typical examples of how various fire hazards can be protected with fixed carbon dioxide extinguishing systems. It should be noted that the methods described are not to be construed as being the only ones that can be used. They are meant to help only in interpreting and elaborating on the intent of the standard where proper application could be subject to question.

**B.2 Commercial/Industrial Food Processing Deep-Fat (Hot Oil) Cookers.** Large deep-fat fryers that are used to continuously cook food products such as meat, fish, and snacks present a fire hazard that requires special attention when designing a carbon dioxide extinguishing system to protect them.

If cooking oil is overheated, it will reach its auto-ignition temperature before it boils away. Therefore, a fire that involves cooking oil vapors can be re-ignited after the initial carbon dioxide discharge by the high temperature of the hot oil in the cooking vat, unless the oil is cooled below the ignition temperature. The energy-efficient design of modern cooking vats makes cooling a slow process.

The arrangement of the equipment to be protected is of prime consideration to proper system design.

First of all, using the cooker can involve external heating of the oil with recirculation of the oil through the cooking vat. This can be considered interexposure. (*See 6.2.1.*)

Second, some cookers are designed such that the fume hood and conveyor can be raised and lowered by a hydraulic system. The combustible food-compatible hydraulic fluids used present another area of protection and can be considered interexposed. (*See 6.2.1.*)

Third, there is a concern that a high-production operation will have an exhaust system that can involve a fume-removal system. This concern should be considered part of the hazard. (*See 6.2.1.*)

The drain board, when subject to oil drippage at the exit end of the conveyor, should be covered. (*See 6.2.1.*)

Finally, the vat presents the largest area to be protected and the greatest need for adequate cooling.

**B.2.1 Summary of Protection.** The following is a quick reference of protection criteria for system design.

**B.2.1.1 Vat.** Where the vat has a movable hood, fire protection by total flooding under the hood is not permitted by 5.1.2 unless the following criteria are met:

- (1) The hood should not be raised during the cooking operation, which means the following:
  - (a) The source of power or fuel to the heating elements is automatically shut off when the hood is raised (e.g., for maintenance or cleaning).
  - (b) A mechanical high-temperature limit switch is employed that will operate any time the temperature of the oil is above the preset temperature limit of not more than 20 percent, in degrees Fahrenheit (degrees Celsius), above the maximum normal oil operating temperature in degrees Fahrenheit (degrees Celsius). Its operation shall cause the following:
    - i. Shutoff of power to the oil heater system
    - ii. Prevention of raising electrically operated hoods
    - iii. Actuation of audible and visible alarms to caution against raising the hood manually
  - (c) The switch should have an automatic reset temperature not higher than 60°F (33.3°C) below the auto-ignition temperature of the cooking oil.
- (2) Before the hood can be raised (e.g., for maintenance and cleaning), a supervised lockout valve should be closed to prevent the discharge of the carbon dioxide system. Closing of the lockout valve should actuate the supervisory trouble alarm on the control unit.
- (3) The source of power or fuel to the heating elements is automatically shut off prior to, or simultaneously with, the system discharge.
- (4) The quantity of carbon dioxide and the duration of discharge are sufficient to maintain an inert atmosphere in the vat until the temperature of the cooking oil is lowered to prevent re-ignition per 5.3.5.6. A minimum reduction of 60°F (33.3°C) below the auto-ignition temperature is recommended.
- (5) The system design is based on discharge testing for the specific fryer model to show compliance with B.2.1.1(4). Documentation of the test should be available upon request by the authority having jurisdiction or the end user.
- (6) Thermal detection should actuate the carbon dioxide system when the temperature is at or below the auto-ignition temperature of the cooking oil.

**B.2.1.2 Permanent Enclosure.** Local application should be designed with the hood in the full up position.

**B.2.1.3 Drain Board.** A local application system using the rate-by-area method per Section 6.4 is appropriate.

**B.2.1.4 Fume-Exhaust and Fume-Removal System.** Total flooding designed to a 65 percent concentration per 5.4.2.1 is appropriate.

**B.2.1.5 External Oil Heater.** A local application system for the recirculating equipment and filters using the rate-by-area method (see Section 6.4) or rate-by-volume method (see Section 6.5), depending on the equipment configuration, is appropriate.

**B.2.1.6 Hydraulic Oil System.** A local application system using the rate-by-area method (see Section 6.4) or rate-by-volume method (see Section 6.5), depending on the equipment configuration, is appropriate.

Because the vat requires a minimum of a 3-minute liquid discharge (see 6.3.3.5.1), the carbon dioxide system design can incorporate two discharge piping systems, one for the vat and one for the remaining interexposed hazards.

**B.2.1.7 Equipment Shutdown.** (See also 4.5.4.9.) Consideration should also be given to personal safety (see Section 4.3) when the system is being designed.

**B.3 Restaurant Range Hoods, Connected Ducts, and Associated Hazards.** The protection of kitchen range hoods and ducts is accomplished with a combination of total flooding and local application systems. The duct or vent stack and the plenum area above the filters can be protected by total flooding. The undersurface of the filters and any special hazards such as deep-fat fryers can be protected by local application. It could be necessary to extend local application protection to coated underhood surfaces and range surfaces if there is danger of grease accumulation or runoff from the hood or duct under fire conditions.

In protecting the duct with the recommended flooding factor of 1 lb/8 ft<sup>3</sup> (2 kg/m<sup>3</sup>) of duct volume, a damper is considered essential at either the top or the bottom, with provisions for automatic closing at the beginning of the discharge of carbon dioxide. For ducts that rise to heights greater than 20 ft (6.1 m) or horizontal runs greater than 50 ft (15.3 m), the gas is introduced at intermediate points to ensure proper distribution. With a damper at the top of the stack, a nozzle should be installed immediately below, with additional nozzles installed above if the duct run extends beyond the damper. A nozzle is normally required in the plenum area.

Nozzles are to be provided to cover the underside of the filters and to discharge for 30 seconds at the coated surface rate specified in 6.4.3.5. In lieu of that, the quantity of carbon dioxide required and application rates can be determined using special nozzles or methods as could be approved or listed for this purpose. If the underside of the hood is largely enclosed by a baffle or drip pan, protection can be by total flooding using a factor of 1 lb/8 ft<sup>3</sup> (2 kg/m<sup>3</sup>) and compensating for open peripheral area. (See 5.3.5.)

Quantities for the protection of deep-fat fryers or other specific fire hazards, or both, below the hood are to be in addition to the preceding requirements. All hazards venting through a common duct should be protected simultaneously.

Automatic fire detection and actuation of the system are required for concealed spaces above the filter and in the duct system. Detectors should also be provided below filters over any deep-fat cookers.

Visible fire detection and manual actuation (see 4.5.4.5) can be acceptable for exposed portions of the hazard; however, actuation by either automatic or manual means should discharge the complete system. Special attention should be given to the choice of heat detectors, considering normal operating temperature level and temperature rise conditions of the range equipment.

Actuation of the system should automatically close dampers, shut off forced ventilating fans, and shut off the master fuel valve or power switch to all cooking equipment associated with the hood. These devices should be of the type that requires manual resetting. (See 4.5.4.9.)

In addition to normal system maintenance, particular care should be given to keeping heat detectors and discharge nozzles clean of grease accumulation. Generally, nozzle seals or caps are required to keep nozzle orifices free of obstruction.

For additional information, see NFPA 96.

**B.4 Newspaper Printing and Rotogravure Presses.** Newspaper, rotogravure, and similar presses constitute a substantial hazard due to the use of highly flammable solvents in the inks, the presence of ink-saturated shredded paper or dust, lubricants, and so forth. In addition to the press units, there can be exhaust ducts, ink-mixing equipment, and associated electrical hazards that require protection. Rotogravure presses use more flammable inks than newspaper printing presses and are equipped with heated drying drums or other drying means and constitute a more severe hazard. However, the basic protection method for both rotogravure and newspaper presses is the same.

Presses are usually arranged in rows (lines) with folders interspersed. The paper can move through the press units to the folder from either side of the folder. Static electrical sparks are a common source of ignition. Flame spread can be from the press units to the folder or from the folder toward the press units.

Presses are “open” or “closed,” depending on whether mist guards or covers are used. With open-type presses, an exhaust system to remove the ink mist is usually required in the press arrangement, and this exhaust system requires simultaneous protection.

Press rooms can be protected by total flooding systems; however, local application-type systems are generally used. Although the press lines and individual press units constitute a series of interexposed hazards, subdividing by lines or suitable grouping within lines is the usual practice for economic reasons. Ventilation ducts, ink storage rooms, and control rooms are usually handled by total flooding methods.

Entire press lines can be protected by local application methods. A press line can be subdivided into groups. In all cases, systems should be capable of giving simultaneous and independent automatic protection to adjacent groups of other lines and also to in-line groups to which the fire can spread. Protection should be designed so that, if a fire occurs near the junction of adjoining groups, the systems protecting both groups will discharge simultaneously.

On individual press groups, the rate of carbon dioxide application can be based on either the rate-by-area or the rate-by-volume method. (See Sections 6.4 and 6.5.)

If the rate-by-area method is used for the presses, the area is based on the full length of the rolls, including the end frames, and on the full height of the roll stack, including the ink reservoir. Both sides of the roll stacks should be included. Color decks should be similarly calculated. Where outside ink reservoirs are used, protection is based on the horizontal area of the reservoir. The floor area under the press should also be protected. On rotogravure presses, the dryers and connecting ductwork are protected by flooding at 1 lb/8 ft<sup>3</sup> (2 kg/m<sup>3</sup>) to be discharged in 30 seconds. When the rate-by-area method is used to determine the amount of carbon dioxide required for folders, carbon dioxide should be applied from both the drive side and the operating side at two levels. Each nozzle will cover an area 4 ft (1.2 m) wide by 4 ft (1.2 m) high.

When the rate-by-volume method is used, the entire group of presses to be protected as a section can be considered as one volume. It is not necessary to add 2 ft (0.6 m) to the sides of each press when the frame constitutes a natural barrier. A single folder can be included in this volume; however, a double-deck folder requires an additional volume block to include the upper deck.

Nozzles should be located to cover the coated surfaces; however, exact placement according to listings or approvals might not be possible. Nozzles should be located to discharge from both ends of the press rolls so as to retain the carbon dioxide within the press volume. The same applies to folders. Protection should be arranged so as to be effective when the mist guards are in place or removed.

The quantity of carbon dioxide required for a single group is based on discharging at the calculated rate for 30 seconds. The reserve supply should be at least sufficient to protect all the adjacent groups that could become involved, including a reserve for the group in which the fire originates. In high-pressure systems, a single reserve bank can be used as a reserve for several main banks; however, the main bank for one group cannot be used as the reserve for another group unless specifically approved by the authority having jurisdiction.

All systems should be arranged for automatic actuation with means for auxiliary manual actuation. At least one heat detector should be located in or over each press unit and folder, depending on the design of the particular unit.

Because of the inherent vibration associated with presses, particular attention should be given to mounting means in order to eliminate vibration damage to tubing or wiring of the detection system.

Immediate detection is particularly important in group protection to prevent the spread of fire beyond the group affected. Because of the need for rapid detection to prevent fire from spreading to adjacent groups or operation of adjacent detectors, or both, the detection system should utilize rate-of-rise, rate-compensated, or equivalent fast-acting detectors.

Complete shutdown of presses, ventilation, pumps, and heat sources simultaneous with system operation is essential.

Audible alarms in the press room and in any basements, pits, or lower levels where carbon dioxide can flow should sound simultaneously with operation of the system. (See A.4.3.)

In addition to normal system maintenance, particular care should be given to ensuring continuance of proper nozzle location and alignment during normal press maintenance procedures. Special attention should also be given to effects of press vibration on heat actuators and connecting tubing or wiring.

**B.5 Open-Top Pits.** Open pits up to 4 ft (1.2 m) deep or up to a depth equal to one-quarter the width, whichever is greater, should be protected on the basis of local application. The area to be considered in determining the quantity of carbon dioxide is the total floor area of the pit less any area covered by a simultaneously protected tank or other equipment for which the quantity is separately calculated. Nozzles are located so as to provide coverage of the protected area in accordance with listing or approval data. It could thus be necessary to locate additional nozzles in the center of the pit.

Open pits that exceed 4 ft (1.2 m) in depth or a depth equal to one-quarter the width, whichever is greater, can be protected



on an area basis using a discharge rate of 4 lb/min·ft<sup>2</sup> (19.5 kg/min·m<sup>2</sup>) of floor area and a discharge time of 30 seconds. The nozzles should be located around the sides of the pit in order to apply the carbon dioxide uniformly from all sides. Care should be taken to use an appropriate number of nozzles with sufficient projection to reach the center areas of large pits. Alternatively, it might be preferable to locate some of the nozzles so that they discharge directly in the pit onto equipment requiring protection, such as pumps, motors, or other critical items. Open-top dip tanks should be protected separately by local application, particularly where the liquid surface is less than 4 ft (1.2 m) or one-quarter the width of the pit from the open top of the pit. Areas of such tanks separately protected wholly within the pit can be deducted from the area of the pit. Objects extending above the top of the pit should be protected using the surface area or the assumed enclosure methods.

If the top of the pit is partially covered so that the open area is less than 3 percent of the cubic foot volume expressed in square feet, the quantity of carbon dioxide required can be determined on a total flooding basis, using an additional quantity of gas for leakage compensation equal to 1 lb/ft<sup>2</sup> (5 kg/m<sup>2</sup>) of open area.

For pits exceeding the minimum specified depth limitation, the discharge nozzles should be located at the two-thirds level above the floor, provided that the discharge rate versus distance factor is not exceeded, so that there will be no danger of splashing any liquids that could be present. In any case, it is preferable to keep the nozzles below the open top to minimize the entrainment of air down into the pit. If the pit exceeds 20 ft (6.1 m) in depth, it is desirable to locate the nozzles somewhat above the two-thirds level from the floor to ensure adequate mixing in the pit. When the quantity of carbon dioxide is computed on the basis of normal total flooding techniques, the nozzle should produce sufficient velocity and turbulence effects to completely fill the pit volume with a thoroughly mixed atmosphere of carbon dioxide and air.

**B.6 Below Raised Floors.** The use of total flooding carbon dioxide fire suppression systems for protection of underfloors typically found in computer rooms and similar types of electronic facilities has been a common practice for several decades.

Experience has shown that there is a potential problem of excessive leakage associated with underfloor protection that can be attributed to a combination of perforated floor tiles and discharge turbulence. Therefore, it is important to design the system to compensate for leakage and to provide a soft discharge to minimize turbulence. The system manufacturer should be consulted for detailed guidance.

Carbon dioxide, being heavier than air, tends to remain trapped and could pose a hazard to personnel entering the underfloor to perform after-fire repairs. After a system discharge, it will be necessary to completely exhaust the carbon dioxide gas from the underfloor after the fire has been extinguished.

In addition, if any service or maintenance is conducted in the underfloor, the carbon dioxide system should be locked out to prevent discharge.

### Annex C Pipe and Orifice Size Determination

*This annex is not a part of the requirements of this NFPA document but is included for informational purposes only.*

▲ **C.1** Computing pipe sizes for carbon dioxide systems is complicated by the fact that the pressure drop is nonlinear with respect to the pipeline. Carbon dioxide leaves the storage vessel as a liquid at saturation pressure. As the pressure drops due to pipeline friction, the liquid boils and produces a mixture of liquid and vapor. Consequently, the volume of the flowing mixture increases and the velocity of flow must also increase. Thus, the pressure drop per unit length of pipe is greater near the end of the pipeline than it is at the beginning.

Pressure drop information for designing piping systems can best be obtained from curves of pressure versus equivalent length for various flow rates and pipe sizes. Such curves can be plotted using the theoretical equation given in 4.7.5.1. The *Y* and *Z* factors in the equation in that paragraph depend on storage pressure and line pressure. In the following equations, *Z* is a dimensionless ratio, and the *Y* factor has units of pressure times density and will therefore change the system of units. The *Y* and *Z* factors can be evaluated as follows:

[C.1a]

$$Y = - \int_{P_1}^P \rho dP$$

$$Z = - \int_{P_1}^P \frac{d\rho}{\rho} = \ln \frac{\rho_1}{\rho}$$

where:

*P* = pressure at end of pipeline [psi (kPa)]

*P*<sub>1</sub> = storage pressure [psi (kPa)]

$\rho$  = density at pressure *P* [lb/ft<sup>3</sup> (kg/m<sup>3</sup>)]

$\rho_1$  = density at pressure *P*<sub>1</sub> [lb/ft<sup>3</sup> (kg/m<sup>3</sup>)]

ln = natural logarithm

The storage pressure is an important factor in carbon dioxide flow. In low-pressure storage, the starting pressure in the storage vessel will recede to a lower level, depending on whether all or only part of the supply is discharged. Because of this, the average pressure during discharge will be about 285 psi (1965 kPa). The flow equation is based on absolute pressure; therefore, 300 psi (2068 kPa) is used for calculations involving low-pressure systems.

In high-pressure systems, the storage pressure depends on the ambient temperature. Normal ambient temperature is assumed to be 70°F (21°C). For this condition, the average pressure in the cylinder during discharge of the liquid portion will be about 750 psi (5171 kPa). This pressure has therefore been selected for calculations involving high-pressure systems.

Using the base pressures of 300 psi (2068 kPa) and 750 psi (5171 kPa), values have been determined for the *Y* and *Z* factors in the flow equation. These values are listed in Table C.1(a) and Table C.1(b).

For practical application, it is desirable to plot curves for each pipe size that can be used. However, the flow equation can be rearranged as shown in the following equation:

$$\frac{L}{D^{1.25}} = \frac{3647Y}{\left(\frac{Q}{D^2}\right)^2} - 8.08Z \quad \text{[C.1b]} \quad \Delta$$

Thus, by plotting values of  $L/D^{1.25}$  and  $Q/D^2$ , it is possible to use one family of curves for any pipe size. Figure C.1(a) gives flow information for 0°F (−18°C) storage temperature on this basis. Figure C.1(b) gives similar information for high-pressure storage at 70°F (21°C). For an inside pipe diameter of exactly 1 in.,  $D^2$  and  $D^{1.25}$  reduce to unity and cancel out. For other pipe sizes, it is necessary to convert the flow rate and equivalent length by dividing or multiplying by these factors. Table C.1(c) gives values for  $D$ .

These curves can be used for designing systems or for checking possible flow rates. For example, assume the problem is to determine the terminal pressure for a low-pressure system consisting of a single 2 in. Schedule 40 pipeline with an equivalent length of 500 ft and a flow rate of 1000 lb/min. The flow rate and the equivalent length must be converted to terms of Figure C.1(a) as follows:

$$\frac{Q}{D^2} = \frac{1000}{4.28} = 234 \text{ lb/min} \cdot \text{in.}^2$$

$$\frac{L}{D^{1.25}} = \frac{500}{2.48} = 201 \text{ ft} \cdot \text{in.}^{1.25} \quad \text{[C.1c]} \quad \Delta$$

From Figure C.1(a), the terminal pressure is found to be about 228 psi at the point where the interpolated flow rate of 234 lb/min intersects the equivalent length scale at 201 ft.

If this line terminates in a single nozzle, the equivalent orifice area must be matched to the terminal pressure in order to control the flow rate at the desired level of 1000 lb/min. Referring to Table 4.7.5.2.1, it will be noted that the discharge rate will be 1410 lb/min·in.<sup>2</sup> of equivalent orifice area when the orifice pressure is 230 psi. The required equivalent orifice area of the nozzle is thus equal to the total flow rate divided by the rate per square inch, as shown in the following equation:

$$\text{Equivalent orifice area} = \frac{1000 \text{ lb/min}}{1410 \text{ lb/min} \cdot \text{in.}^2} = 0.709 \text{ in.}^2 \quad \text{[C.1d]}$$

From a practical viewpoint, the designer would select a standard nozzle having an equivalent area nearest to the computed area. If the orifice area happened to be a little larger, the actual flow rate would be slightly higher and the terminal pressure would be somewhat lower than the estimated 228 psi (1572 kPa).

If, in the previous example, instead of terminating with one large nozzle, the pipeline branched into two smaller pipelines, it would be necessary to determine the pressure at the end of each branch line. To illustrate this procedure, assume that the branch lines are equal and consist of 1½ in. Schedule 40 pipe with equivalent lengths of 200 ft (61 m) and that the flow in each branch line is to be 500 lb/min (227 kg/min). Converting to terms used in Figure C.1(a), the following equations result:

$$\frac{Q}{D^2} = \frac{500}{2.592} = 193 \text{ lb/min} \cdot \text{in.}^2 \quad \text{[C.1e]}$$

$$\frac{L}{D^{1.25}} = \frac{200}{1.813} = 110 \text{ ft/in.}^{1.25}$$

From Figure C.1(a), the starting pressure of 228 psi (1572 kPa) (terminal pressure of main line) intersects the flow rate line [193 lb/min (87.6 kg/min)] at an equivalent length of about 300 ft (91.4 m). In other words, if the branch line started at the storage vessel, the liquid carbon dioxide would have to flow through 300 ft (91.4 m) of pipeline before the pressure dropped to 228 psi (1572 kPa). This length thus becomes the starting point for the equivalent length of the branch line. The terminal pressure of the branch line is then found to be 165 psi (1138 kPa) at the point where the 193 lb/min (87.6 kg/min) flow rate line intersects the total equivalent length line of 410 ft (125 m), or 300 ft + 110 ft (91 m + 34 m). With this new terminal pressure [165 psi (1138 kPa)] and flow rate [500 lb/min (227 kg/min)], the required equivalent nozzle area at the end of each branch line will be approximately 0.567 in.<sup>2</sup> (366 mm<sup>2</sup>). This is about the same as the single large nozzle example, except that the discharge rate is cut in half due to the reduced pressure.

The design of the piping distribution system is based on the flow rate desired at each nozzle. This in turn determines the required flow rate in the branch lines and the main pipeline. From practical experience, it is possible to estimate the approximate pipe sizes required. The pressure at each nozzle can be determined from suitable flow curves. The nozzle orifice sizes are then selected on the basis of nozzle pressure from the data given in 4.7.5.2.

In high-pressure systems, the main header is supplied by a number of separate cylinders. The total flow is thus divided by the number of cylinders to obtain the flow rate from each cylinder. The flow capacity of the cylinder valve and the connector to the header vary with each manufacturer, depending on design and size. For any particular valve, dip tube, and connector assembly, the equivalent length can be determined in terms of feet of standard pipe size. With this information, the flow equation can be used to prepare a curve of flow rate versus pressure drop. This curve provides a convenient method of determining header pressure for a specific valve and connector combination.

Table C.1(d) and Table C.1(e) list the equivalent lengths of pipe fittings for determining the equivalent length of piping systems. Table C.1(d) is for threaded joints, and Table C.1(e) is for welded joints. Both tables were computed for Schedule 40 pipe sizes; however, for all practical purposes, the same figures can also be used for Schedule 80 pipe sizes.

For nominal changes in elevation of piping, the change in head pressure is negligible. However, if there is a substantial change in elevation, this factor should be taken into account. The head pressure correction per foot of elevation depends on the average line pressure where the elevation takes place because the density changes with pressure. Correction factors are given in Table C.1(f) and Table C.1(g) for low-pressure and high-pressure systems, respectively. The correction is subtracted from the terminal pressure when the flow is upward and is added to the terminal pressure when the flow is downward.

**Table C.1(a) Values of Y and Z for 300 psi Initial Storage Pressure**

Pressure (psi)	Z	Y									
		0	1	2	3	4	5	6	7	8	9
300	0.000	0	0	0	0	0	0	0	0	0	0
290	0.135	596	540	483	426	367	308	248	187	126	63
280	0.264	1119	1070	1020	969	918	866	814	760	706	652
270	0.387	1580	1536	1492	1448	1402	1357	1310	1263	1216	1168
260	0.505	1989	1950	1911	1871	1831	1790	1749	1708	1666	1623
250	0.620	2352	2318	2283	2248	2212	2176	2139	2102	2065	2027
240	0.732	2677	2646	2615	2583	2552	2519	2487	2454	2420	2386
230	0.841	2968	2940	2912	2884	2855	2826	2797	2768	2738	2708
220	0.950	3228	3204	3179	3153	3128	3102	3075	3049	3022	2995
210	1.057	3462	3440	3418	3395	3372	3349	3325	3301	3277	3253
200	1.165	3673	3653	3632	3612	3591	3570	3549	3528	3506	3485
190	1.274	3861	3843	3825	3807	3788	3769	3750	3731	3712	3692
180	1.384	4030	4014	3998	3981	3965	3948	3931	3914	3896	3879
170	1.497	4181	4167	4152	4138	4123	4108	4093	4077	4062	4046
160	1.612	4316	4303	4291	4277	4264	4251	4237	4223	4210	4196
150	1.731	4436	4425	4413	4402	4390	4378	4366	4354	4341	4329

△ Table C.1(b) Values of Y and Z for 750 psi Initial Storage Pressure

Pressure (psi)	Z	Y									
		0	1	2	3	4	5	6	7	8	9
750	0.000	0	0	0	0	0	0	0	0	0	0
740	0.038	497	448	399	350	300	251	201	151	101	51
730	0.075	975	928	881	833	786	738	690	642	594	545
720	0.110	1436	1391	1345	1299	1254	1208	1161	1115	1068	1022
710	0.143	1882	1838	1794	1750	1706	1661	1616	1572	1527	1481
700	0.174	2314	2271	2229	2186	2143	2100	2057	2013	1970	1926
690	0.205	2733	2691	2650	2608	2567	2525	2483	2441	2399	2357
680	0.235	3139	3099	3059	3018	2978	2937	2897	2856	2815	2774
670	0.265	3533	3494	3455	3416	3377	3338	3298	3259	3219	3179
660	0.296	3916	3878	3840	3802	3764	3726	3688	3649	3611	3572
650	0.327	4286	4250	4213	4176	4139	4102	4065	4028	3991	3953
640	0.360	4645	4610	4575	4539	4503	4467	4431	4395	4359	4323
630	0.393	4993	4959	4924	4890	4855	4821	4786	4751	4716	4681
620	0.427	5329	5296	5263	5229	5196	5162	5129	5095	5061	5027
610	0.462	5653	5621	5589	5557	5525	5493	5460	5427	5395	5362
600	0.498	5967	5936	5905	5874	5843	5811	5780	5749	5717	5685
590	0.535	6268	6239	6209	6179	6149	6119	6089	6058	6028	5997
580	0.572	6560	6531	6502	6473	6444	6415	6386	6357	6328	6298
570	0.609	6840	6812	6785	6757	6729	6701	6673	6645	6616	6588
560	0.646	7110	7084	7057	7030	7003	6976	6949	6922	6895	6868
550	0.683	7371	7345	7320	7294	7268	7242	7216	7190	7163	7137
540	0.719	7622	7597	7572	7548	7523	7498	7472	7447	7422	7396
530	0.756	7864	7840	7816	7792	7768	7744	7720	7696	7671	7647
520	0.792	8098	8075	8052	8028	8005	7982	7958	7935	7911	7888
510	0.827	8323	8301	8278	8256	8234	8211	8189	8166	8143	8120
500	0.863	8540	8519	8497	8476	8454	8433	8411	8389	8367	8345
490	0.898	8750	8730	8709	8688	8667	8646	8625	8604	8583	8562
480	0.933	8953	8933	8913	8893	8873	8852	8832	8812	8791	8771
470	0.967	9149	9129	9110	9091	9071	9052	9032	9012	8993	8973
460	1.002	9338	9319	9301	9282	9263	9244	9225	9206	9187	9168
450	1.038	9520	9502	9484	9466	9448	9430	9412	9393	9375	9356
440	1.073	9697	9680	9662	9644	9627	9609	9592	9574	9556	9538
430	1.109	9866	9850	9833	9816	9799	9782	9765	9748	9731	9714
420	1.146	10030	10014	9998	9982	9966	9949	9933	9916	9900	9883
410	1.184	10188	10173	10157	10141	10126	10110	10094	10078	10062	10046
400	1.222	10340	10325	10310	10295	10280	10265	10250	10234	10219	10204
390	1.262	10486	10472	10458	10443	10429	10414	10399	10385	10370	10355
380	1.302	10627	10613	10599	10585	10571	10557	10543	10529	10515	10501
370	1.344	10762	10749	10735	10722	10708	10695	10681	10668	10654	10641
360	1.386	10891	10878	10866	10853	10840	10827	10814	10801	10788	10775
350	1.429	11015	11003	10991	10978	10966	10954	10941	10929	10916	10904
340	1.473	11134	11122	11110	11099	11087	11075	11063	11051	11039	11027
330	1.518	11247	11236	11225	11214	11202	11191	11180	11168	11157	11145
320	1.564	11356	11345	11334	11323	11313	11302	11291	11280	11269	11258
310	1.610	11459	11449	11439	11428	11418	11408	11398	11387	11377	11366
300	1.657	11558	11548	11539	11529	11519	11509	11499	11489	11479	11469



▲ Table C.1(c) Values of  $D^{1.25}$  and  $D^2$  for Various Pipe Sizes

Pipe Size and Type	Inside Diameter (in.)	$D^{1.25}$	$D^2$
½ Std.	0.622	0.5521	0.3869
¾ Std.	0.824	0.785	0.679
1 Std.	1.049	1.0615	1.100
1 XH	0.957	0.9465	0.9158
1¼ Std.	1.380	1.496	1.904
1¼ XH	1.278	1.359	1.633
1½ Std.	1.610	1.813	2.592
1½ XH	1.500	1.660	2.250
2 Std.	2.067	2.475	4.272
2 XH	1.939	2.288	3.760
2½ Std.	2.469	3.09	6.096
2½ XH	2.323	2.865	5.396
3 Std.	3.068	4.06	9.413
3 XH	2.900	3.79	8.410
4 Std.	4.026	5.71	16.21
4 XH	3.826	5.34	14.64
5 Std.	5.047	7.54	25.47
5 XH	4.813	7.14	23.16
6 Std.	6.065	9.50	36.78
6 XH	5.761	8.92	33.19

▲ Table C.1(d) Equivalent Lengths in Feet of Threaded Pipe Fitting

Pipe Size (in.)	Elbow			Tee Side	Union Coupling or Gate Valve
	Std. 45 Degrees	Std. 90 Degrees	90 Degrees Long Radius and Tee Thru Flow		
⅜	0.6	1.3	0.8	2.7	0.3
½	0.8	1.7	1.0	3.4	0.4
¾	1.0	2.2	1.4	4.5	0.5
1	1.3	2.8	1.8	5.7	0.6
1¼	1.7	3.7	2.3	7.5	0.8
1½	2.0	4.3	2.7	8.7	0.9
2	2.6	5.5	3.5	11.2	1.2
2½	3.1	6.6	4.1	13.4	1.4
3	3.8	8.2	5.1	16.6	1.8
4	5.0	10.7	6.7	21.8	2.4
5	6.3	13.4	8.4	27.4	3.0
6	7.6	16.2	10.1	32.8	3.5

For SI units, 1 ft = 0.3048 m.

▲ Table C.1(e) Equivalent Lengths in Feet of Welded Pipe Fitting

Pipe Size (in.)	Elbow 90 Degrees Long Radius and Tee Thru Flow				
	Std. 45 Degrees	Std. 90 Degrees	Tee Side	Gate Valve	
⅜	0.2	0.7	0.5	1.6	0.3
½	0.3	0.8	0.7	2.1	0.4
¾	0.4	1.1	0.9	2.8	0.5
1	0.5	1.4	1.1	3.5	0.6
1¼	0.7	1.8	1.5	4.6	0.8
1½	0.8	2.1	1.7	5.4	0.9
2	1.0	2.8	2.2	6.9	1.2
2½	1.2	3.3	2.7	8.2	1.4
3	1.8	4.1	3.3	10.2	1.8
4	2.0	5.4	4.4	13.4	2.4
5	2.5	6.7	5.5	16.8	3.0
6	3.0	8.1	6.6	20.2	3.5

For SI units, 1 ft = 0.3048 m.

Table C.1(f) Elevation Correction Factors for Low-Pressure System

Average Line Pressure		Elevation Correction	
psi	kPa	psi/ft	kPa/m
300	2068	0.443	10.00
280	1930	0.343	7.76
260	1792	0.265	5.99
240	1655	0.207	4.68
220	1517	0.167	3.78
200	1379	0.134	3.03
180	1241	0.107	2.42
160	1103	0.085	1.92
140	965	0.067	1.52

Table C.1(g) Elevation Correction Factors for High-Pressure System

Average Line Pressure		Elevation Correction	
psi	kPa	psi/ft	kPa/m
750	5171	0.352	7.96
700	4826	0.300	6.79
650	4482	0.255	5.77
600	4137	0.215	4.86
550	3792	0.177	4.00
500	3447	0.150	3.39
450	3103	0.125	2.83
400	2758	0.105	2.38
350	2413	0.085	1.92
300	2068	0.070	1.58

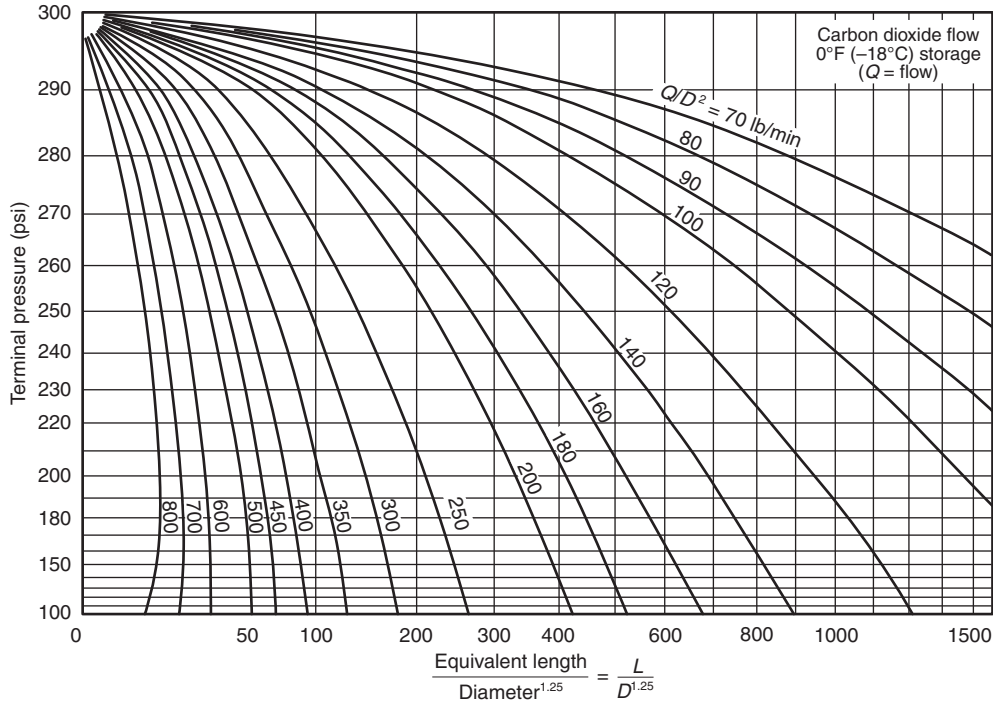

**FIGURE C.1(a) Pressure Drop in Pipeline for 300 psi (2068 kPa) Storage Pressure.**

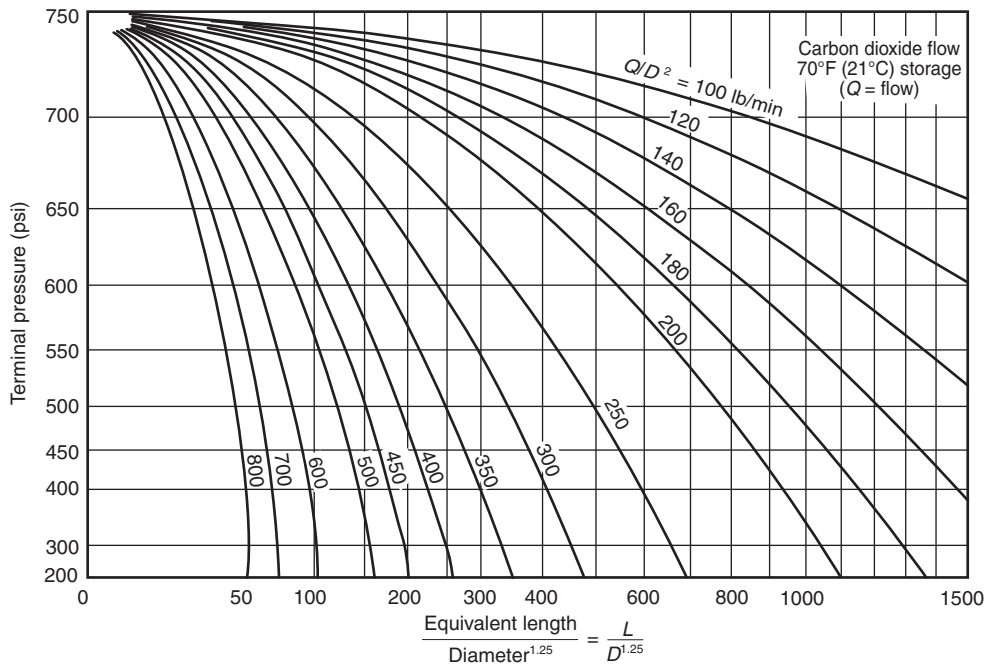

**FIGURE C.1(b) Pressure Drop in Pipeline for 750 psi (5171 kPa) Storage Pressure.**

## Annex D Total Flooding Systems

*This annex is not a part of the requirements of this NFPA document but is included for informational purposes only.*

**D.1 Design Theory.** From a performance viewpoint, a total flooding system is designed to develop a carbon dioxide concentration that will extinguish fires in combustible materials located in an enclosed space. It should also maintain an effective concentration until the maximum temperature has been reduced below the re-ignition point.

For many materials, there could be a need to maintain a concentration of carbon dioxide to allow for cooling. Sheet metal ducting that can be heated quickly and substantially is an example of where maintaining the concentration for cooling can be necessary.

The concentration of carbon dioxide required depends on the type of combustible material involved. The concentration of carbon dioxide has been accurately determined for most surface-type fires, particularly those involving liquids and gases. Most of this information has been obtained by the U.S. Bureau of Mines. For deep-seated fires, the critical concentration required for extinguishment is less definite and has in general been established by practical test work.

The volume of carbon dioxide required to develop a given concentration will be greater than the final volume remaining in the enclosure. In most cases, carbon dioxide should be applied in a manner that promotes progressive mixing of the atmosphere. The displaced atmosphere is exhausted freely from the enclosure through various small openings or through special vents, as carbon dioxide is injected. Some carbon dioxide is therefore lost with the vented atmosphere. This loss becomes greater at high concentrations. This method of application is called free-efflux flooding.

Under the preceding conditions, the volume of carbon dioxide required to develop a given concentration in the atmosphere is expressed by the following equations:

[D.1a]

$$e^x = \frac{100}{100 - \%CO_2}$$

or

[D.1b]

$$X = 2.303 \log_{10} \frac{100}{100 - \%CO_2}$$

where:

$e$  = 2.718 (natural logarithm base)

$X$  = volume of carbon dioxide added per volume of space

From the preceding equations, the volume of carbon dioxide required to develop a given concentration can be calculated. This quantity of carbon dioxide can be expressed in terms of cubic feet (cubic meters) of space protected per pound (kilogram) of carbon dioxide or pounds (kilograms) of carbon dioxide per 100 ft<sup>3</sup> (0.28 m<sup>3</sup>). These results have been calculated and plotted for easy reference.

One such curve is shown on Figure D.1(a). On this curve, it was assumed that the carbon dioxide would expand to a volume of 9 ft<sup>3</sup>/lb (0.56 m<sup>3</sup>/kg) at a temperature of 86°F (30°C). The top curve (complete displacement) and the bottom curve (no efflux) are theoretical extremes plotted for comparative purposes only. The middle curve (free efflux), the curve to be used, must be tempered by proper safety factors. Similar information is also given on Figure D.1(b) in the form of a nomograph. Column A shows oxygen content of air-carbon dioxide mixtures; Column B shows weights of carbon dioxide in air-carbon dioxide mixtures; and Column C shows cubic feet per pound of carbon dioxide in air-carbon dioxide mixtures. In this case, it was assumed that the final temperature would be about 50°F (10°C), giving a volume of 8.35 ft<sup>3</sup>/lb (0.52 m<sup>3</sup>/kg) of carbon dioxide. The nomograph therefore indicates somewhat greater quantities of carbon dioxide for the same concentration. The data in Chapters 4 through 6 are based on an expansion of 9 ft<sup>3</sup>/lb (0.56 m<sup>3</sup>/kg) of carbon dioxide. It should be noted that, in some well-insulated enclosures, such as freezers and anechoic test chambers, complete and rapid vaporization of the carbon dioxide discharge might not occur. For unusual cases like these, the manufacturer should be consulted.

The time required for cooling below the re-ignition point depends on the type of fire and the insulating effect of the combustible material. For surface-type fires, it can be assumed that the fire will be extinguished almost as soon as the desired concentration is obtained. The enclosure should, of course, retain a reasonable concentration for some time after the carbon dioxide has been injected, which provides an additional factor of safety.

For deep-seated fires, the concentration should be maintained for a longer period of time because the hot material will cool off slowly. The cooling time varies considerably, depending on the nature of the material. Because the cooling time tends to be long, it is necessary to give considerable attention to the problem of maintaining the extinguishing concentration. Surface fires and deep-seated fires are basically different and should be approached with somewhat different objectives in mind.

Examples of hazards protected by total flooding systems include rooms, vaults, enclosed machines, ducts, ovens, containers, and the contents thereof.

**D.2 Additional Resources.** The design of a total flooding carbon dioxide system can be a challenging task. The need to address material conversion factors, temperature variations, and unclosable openings are just a few of the obstacles. The FSSA publication, *Design Guide for Use with Carbon Dioxide Total Flooding Applications*, takes the user through the design of a CO<sub>2</sub> system, complete with examples.

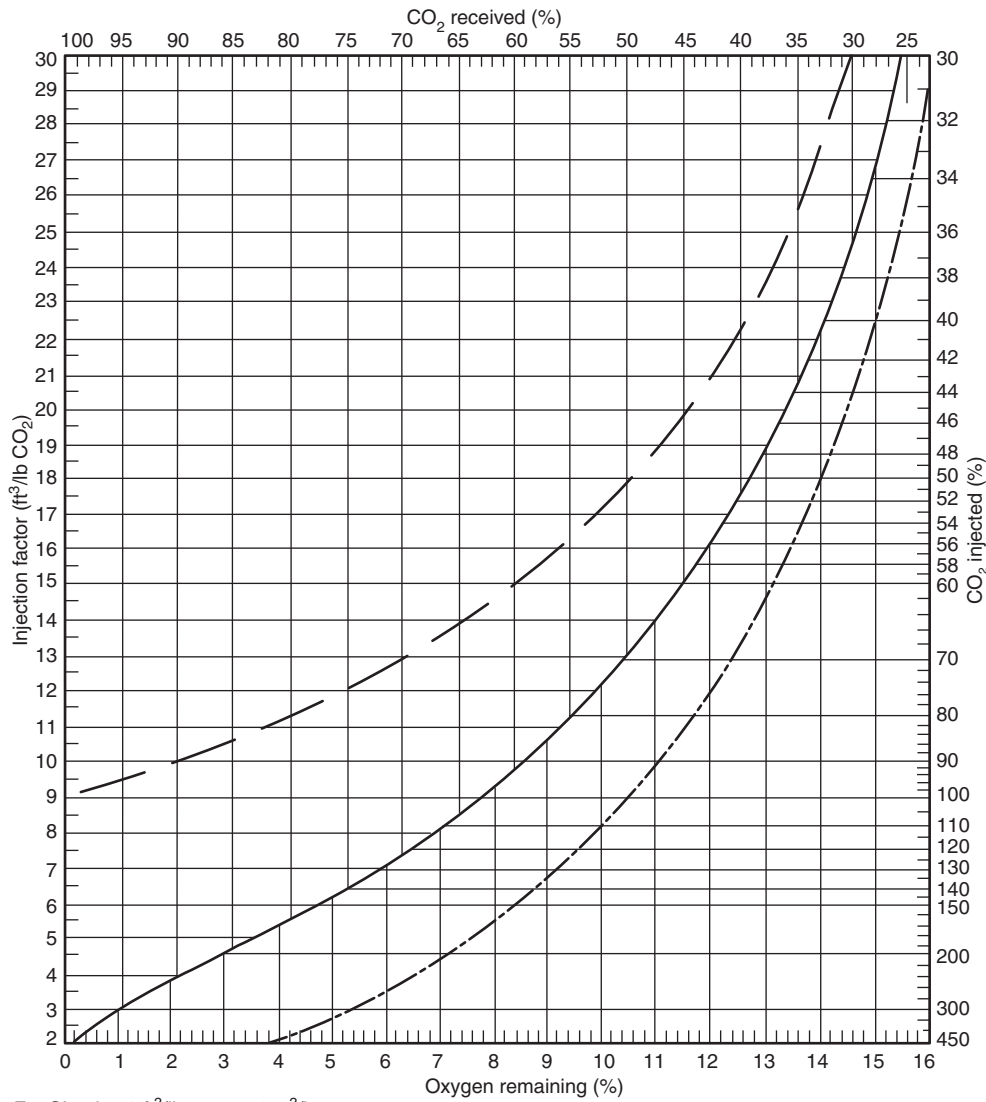

For SI units, 1 ft<sup>3</sup>/lb = 0.0624 m<sup>3</sup>/kg.

**FIGURE D.1(a) Carbon Dioxide Requirements for Inert Atmospheres [based on a carbon dioxide expansion of 9 ft<sup>3</sup>/lb (0.56 m<sup>3</sup>/kg)].**



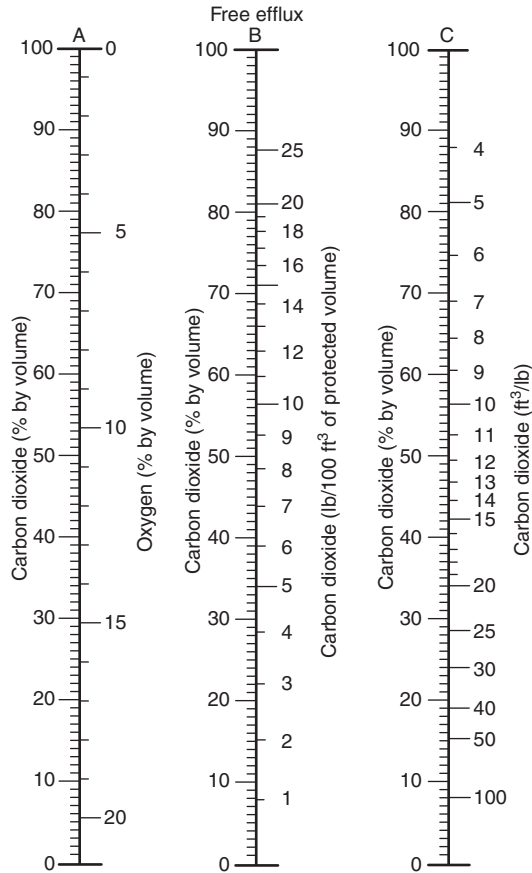

For SI units, 1 lb/ft<sup>3</sup> = 16.018 kg/m<sup>3</sup>; 1 ft<sup>3</sup>/lb = 0.0624 m<sup>3</sup>/kg.

**FIGURE D.1(b) Carbon Dioxide Requirements for Inert Atmospheres [based on a carbon dioxide expansion of 8.35 ft<sup>3</sup>/lb (0.52 m<sup>3</sup>/kg)].**

**Annex E Surface Fires**

*This annex is not a part of the requirements of this NFPA document but is included for informational purposes only.*

**▲ E.1** The requirements given in Section 5.3 take into account the various factors that could affect the performance of the carbon dioxide system. The question on limitation of unclosable openings is frequently encountered and is difficult to answer in precise terms. Because surface fires are normally of the type that can be extinguished with local application methods, a choice between total flooding or local application can be made on the basis of the quantity of carbon dioxide required. This choice is illustrated in the following examples for the enclosure diagrammed in Figure E.1 (a).

**Example 1:**

Volume of space	2000 ft <sup>3</sup>
Type of combustible	Gasoline
Ventilation openings	
Air outlet near ceiling	5 ft <sup>2</sup>
Air inlet centered at 7 ft below ceiling	5 ft <sup>2</sup>
Design concentration (See Table 5.3.2.2.)	34% CO <sub>2</sub>
Volume factor [See Table 5.3.3(a).]	18 ft <sup>3</sup> /lb CO <sub>2</sub>
Basic quantity of CO <sub>2</sub>	$\frac{2000}{18} = 111 \text{ lb}$

Material conversion factor (see 5.3.4): Because the design concentration is not over 34 percent, no conversion is needed.

Special conditions (see 5.3.5): Carbon dioxide will be lost through the bottom opening while air enters through the top opening. From Figure E.1 (b), the loss rate will be 17 lb/min·ft<sup>2</sup> for a concentration of 34 percent at 7 ft.

Additional carbon dioxide for openings (see 5.3.5.1):

$17 \times 5 = 85 \text{ lb}$

Total carbon dioxide required:

$111 + 85 = 196 \text{ lb}$

**Example 1 (SI units):**

Volume of space	54 m <sup>3</sup>
Type of combustible	Gasoline
Ventilation openings	
Air outlet near ceiling	0.5 m <sup>2</sup>
Air inlet centered at 2.1 m below ceiling	0.5 m <sup>2</sup>
Design concentration (See Table 5.3.2.2.)	34% CO <sub>2</sub>
Volume factor [See Table 5.3.3(b).]	1.11 m <sup>3</sup> /kg CO <sub>2</sub>
Basic quantity of CO <sub>2</sub>	$\frac{54}{1.11} = 48.6 \text{ kg}$

Material conversion factor (*see 5.3.4*): Because the design concentration is not over 34 percent, no conversion is needed.

Special conditions (*see 5.3.5*): Carbon dioxide will be lost through the bottom opening while air enters through the top opening. From Figure E.1(b), the loss rate will be 85 kg/min·m<sup>2</sup> for a concentration of 34 percent at 2.1 m.

Additional carbon dioxide for openings (*see 5.3.5.1*):

$$85 \times 0.5 = 42.5 \text{ kg}$$

Total carbon dioxide required:

$$48.6 + 42.5 = 91.1 \text{ kg}$$

**Example 2:**

Volume of space	2000 ft <sup>3</sup>
Type of combustible	Gasoline
Ventilation openings	
Air outlet near ceiling	10 ft <sup>2</sup>
Air inlet centered at 7 ft below ceiling	10 ft <sup>2</sup>
Design concentration ( <i>See Table 5.3.2.2.</i> )	34% CO <sub>2</sub>
Basic quantity of CO <sub>2</sub>	$\frac{2000}{18} = 111 \text{ lb}$

Additional carbon dioxide for openings (*see 5.3.5.1*):

$$17 \times 10 = 170 \text{ lb}$$

Total carbon dioxide required:

$$111 + 170 = 281 \text{ lb}$$

Because the compensation exceeds the basic flooding requirement (*see 5.2.1.1*), refer to Chapter 6. Using the rate-by-volume method, 6.5.3.2 states that the rate of discharge can be reduced to not less than 0.25 lb/min·ft<sup>3</sup> for actual walls completely surrounding the hazard enclosure. The openings can be calculated as a percentage of wall enclosure to determine a proper discharge rate. The total opening area is 20 ft<sup>2</sup>.

$$\text{Total wall area: } (10 + 10 + 20 + 20) \times 10 = 600 \text{ ft}^2$$

Rate of discharge:

$$\frac{20}{600} \times (1 - 0.25) + 0.25 = 0.27 \text{ lb/min} \cdot \text{ft}^3$$

Total rate of discharge:

$$0.27 \times 2000 = 540 \text{ lb/min}$$

Quantity of carbon dioxide:

$$\frac{540}{2} = 270 \text{ lb}$$

Local application requires a liquid discharge for 30 seconds. In the case of high-pressure storage, the quantity of carbon dioxide must be increased by 40 percent (*see 6.3.1.1*) to ensure a 30-second discharge of liquid. When the openings are increased to 20 ft<sup>2</sup> each, local application techniques will require less carbon dioxide than total flooding for both low-pressure and high-pressure storage.

**Example 2 (SI units):**

Volume of space	54 m <sup>3</sup>
Type of combustible	Gasoline
Ventilation openings	
Air outlet near ceiling	1.0 m <sup>2</sup>
Air inlet centered at 2.1 m below ceiling	1.0 m <sup>2</sup>
Design concentration ( <i>See Table 5.3.2.2.</i> )	34% CO <sub>2</sub>
Basic quantity of CO <sub>2</sub>	$\frac{54}{1.11} = 48.6 \text{ kg}$

Additional carbon dioxide for openings (*see 5.3.5.1*):

$$85 \times 1.0 = 85 \text{ kg}$$

Total carbon dioxide required:

$$48.6 + 85 = 133.6 \text{ kg}$$

Because the compensation exceeds the basic flooding requirement (*see 5.2.1.1*), refer to Chapter 6. Using the rate-by-volume method, 6.5.3.2 states that the rate of discharge can be reduced to not less than 4 kg/min·m<sup>3</sup> for actual walls completely surrounding the hazard enclosure. The openings can be calculated as a percentage of wall enclosure to determine a proper discharge rate. The total opening area is 2.0 m<sup>2</sup>.

$$\text{Total wall area: } (3 + 3 + 6 + 6) \times 3 = 54 \text{ m}^2$$

Rate of discharge:

$$\frac{2.0}{54} \times (16 - 4) + 4 = 4.4 \text{ kg/min} \cdot \text{m}^3$$

Total rate of discharge:

$$4.4 \times 54 = 237.6 \text{ kg/min} \cdot \text{m}^3$$

Quantity of carbon dioxide:

$$\frac{237.6}{2} = 118.8 \text{ kg}$$

Local application requires a liquid discharge for 30 seconds. In the case of high-pressure storage, the quantity of carbon dioxide must be increased by 40 percent (*see 6.3.1.1*) to ensure a 30-second discharge of liquid. When the openings are increased to 2.0 m<sup>2</sup> each, local application techniques will require less carbon dioxide than total flooding for both low-pressure and high-pressure storage.

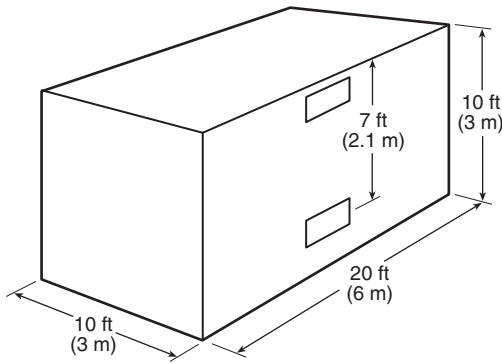

**FIGURE E.1(a) Diagram of Enclosure for Example 1 and Example 2.**

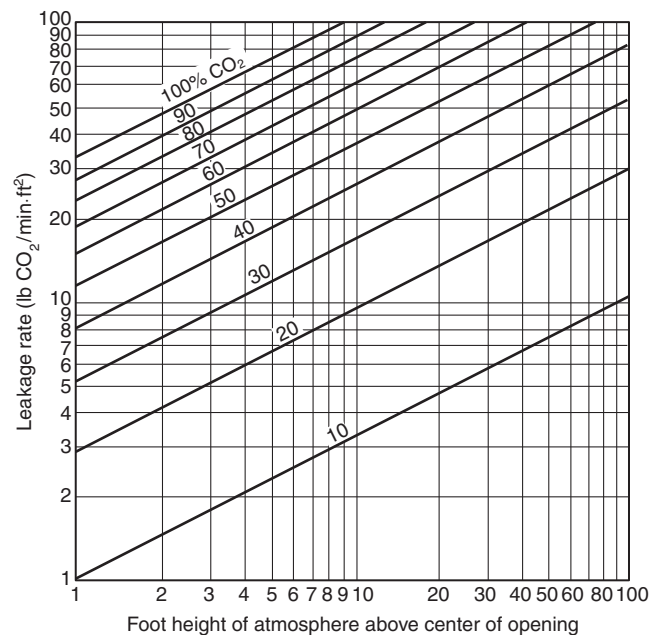

For SI units, 1 ft = 0.305 m; 1 lb/min-ft<sup>2</sup> = 4.89 kg/min-m<sup>2</sup>.

**FIGURE E.1(b) Calculated CO<sub>2</sub> Loss Rate Based on an Assumed 70°F (21°C) Temperature Within the Enclosure and 70°F (21°C) Ambient Outside.**

## Annex F Local Application Carbon Dioxide Systems

*This annex is not a part of the requirements of this NFPA document but is included for informational purposes only.*

**F.1** A local application carbon dioxide system is designed to apply carbon dioxide directly to a fire that could occur in an area or space that essentially has no enclosure surrounding it. Such systems should be designed to deliver carbon dioxide to the hazard being protected in a manner that will cover or surround all burning or flaming surfaces with carbon dioxide during operation of the system.

The flow rate and time of application required depend on the type of combustible material involved, the nature of the hazard (whether it is a liquid surface, such as a dip tank or quench tank, or a complicated piece of machinery, such as a printing press), and the location and spacing of the carbon dioxide nozzles with respect to the hazard.

The important factors to be considered in the design of a local application system are the rate of flow, the height and area limitations of the nozzles used, the amount of carbon dioxide needed, and the piping system. The following steps are necessary to lay out a system:

- (1) Determine the area of the hazard to be protected. In determining this area, it is important to lay out to scale the actual hazard, showing all dimensions and limitations as to placement of nozzles. The limits of the hazard should be carefully defined to include all combustibles that could be included in the hazard, and the possibility of stock or other obstructions that might be in or near the hazard should be carefully considered.
- (2) For overhead-type nozzles, based on the height limitations of the hazard to be protected, lay out the nozzles to cover the hazard by using various nozzles within the height and area limitations that are expressed in the listings or approvals of these nozzles. The limits on area coverage of a nozzle for a particular height are determined from listing information, which is presented in a form similar to that shown in Figure F.1(a). In considering the area covered by a particular nozzle, it is important to remember that all nozzle coverage is laid out on the basis of approximate squares. Omit this step for tankside or linear-type nozzles.
- (3) Based on the height above the hazard of each nozzle, determine the optimum flow rate at which each nozzle should discharge to extinguish the hazard being protected. This is determined from a curve such as the one shown in Figure F.1(b), given in the individual listings or approvals of nozzles. For tankside or linear nozzles, based on the configuration of the hazard, lay out the nozzles to cover the hazard within the spacing limitations expressed in approvals or listings. Based on the spacing or area coverage, select an appropriate flow rate from an approval or listing curve such as the ones shown by Figure F.1(c) and Figure F.1(d). Omit this step for overhead-type nozzles.
- (4) Determine the discharge time for the hazard. This time will always be a minimum of 30 seconds, but it can be longer, depending on such factors as the nature of the material in the hazard and the possibility that some hot spots can require longer cooling.
- (5) Add the flow rates of the individual nozzles to determine the total flow rate, and multiply this sum by the duration of discharge to determine the total quantity of carbon dioxide needed to protect the hazard. Then multiply that number by 1.4 (for high-pressure systems) to obtain total capacity of storage cylinders.
- (6) Locate the storage tank or cylinders, and lay out the piping connecting the nozzles and storage containers.
- (7) Starting from the storage cylinders, compute the pressure drop through the system piping to each nozzle to obtain the terminal pressure at each nozzle. (See Section C.1.) Be sure to allow for equivalent lengths of pipe for various fittings and system components. Equivalent lengths of system components are found in individual listings or approvals of these components. Assume 750 psi

(5171 kPa) storage conditions for high-pressure storage and 300 psi (2068 kPa) storage conditions for low-pressure storage of carbon dioxide. For the initial layout, it is necessary to assume sizes of the piping at various points in the system. After going through the computations to determine the nozzle pressures, it could be necessary to adjust these pipe sizes up or down to obtain higher or lower nozzle pressures so that a proper flow rate can be achieved.

- (8) Based on the nozzle pressures from step (7) and the individual nozzle flow rates from step (3), select an equivalent orifice that comes closest to the area that produces the design flow rate using Table 4.7.5.2.1, Table 4.7.5.3.1, and Table A.4.7.4.4.3.

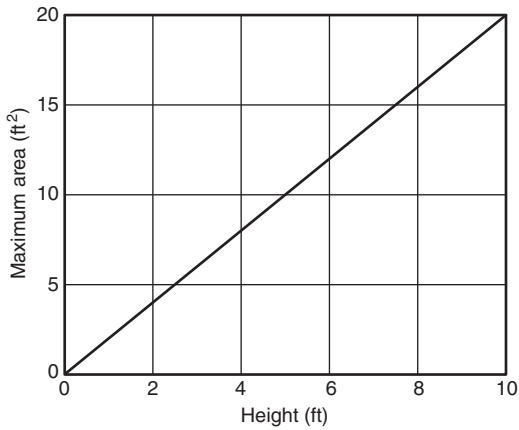

For SI units, 1 ft = 0.305 m; 1 ft<sup>2</sup> = 0.0929 m<sup>2</sup>.

**FIGURE F.1(a)** Listing or Approval Curve of a Typical Nozzle Showing Maximum Area Versus Height or Distance from Liquid Surface.

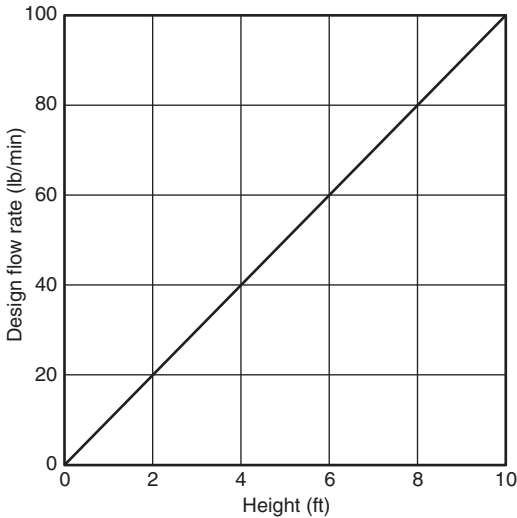

For SI units, 1 ft = 0.305 m; 1 lb/min = 0.454 kg/min.

**FIGURE F.1(b)** Listing or Approval Curve of a Typical Nozzle Showing Design Flow Rate Versus Height or Distance from Liquid Surface.

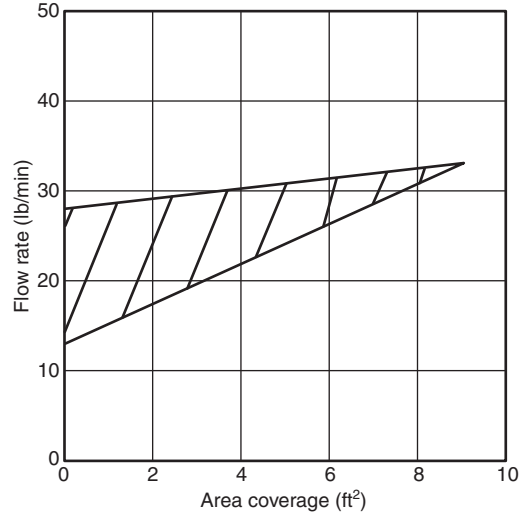

For SI units, 1 ft<sup>2</sup> = 0.0929 m<sup>2</sup>; 1 lb/min = 0.454 kg/min.

**FIGURE F.1(c)** Typical Listing or Approval Curve of a Tankside Nozzle Showing Flow Rate Versus Area Coverage.

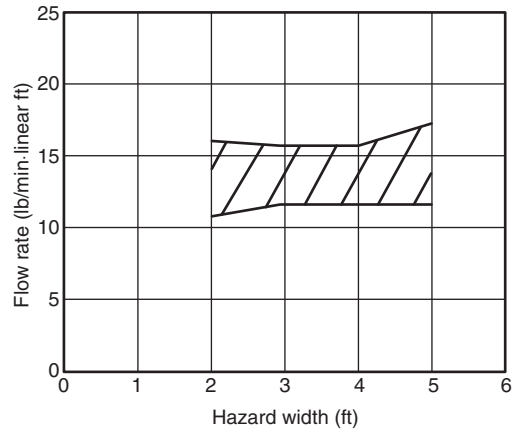

For SI units, 1 ft = 0.305 m; 1 lb/min-ft = 1.49 kg/min-m.

**FIGURE F.1(d)** Typical Listing or Approval Curve of a Linear Nozzle Showing Flow Rate Versus Hazard Width.



### Annex G General Information on Carbon Dioxide

*This annex is not a part of the requirements of this NFPA document but is included for informational purposes only.*

**G.1** Carbon dioxide is present in the atmosphere at an average concentration of about 0.03 percent by volume. It is also a normal end product of human and animal metabolism. Carbon dioxide influences certain vital functions in a number of important ways, including control of respiration, dilation and constriction of the vascular system — particularly the cerebrum — and the pH of body fluids. The concentration of carbon dioxide in the air governs the rate at which carbon dioxide is released from the lungs and thus affects the concentration of carbon dioxide in the blood and tissues. An increasing concentration of carbon dioxide in air can, therefore, become dangerous due to a reduction in the rate of release of carbon dioxide from the lungs and decreased oxygen intake. [Further details of carbon dioxide exposure can be obtained from DHHS (NIOSH) Publication No. 76-194.] Personnel safety considerations are covered in Section 4.3.

Table G.1 provides information on acute health effects of high concentrations of carbon dioxide.

Carbon dioxide is a standard commercial product with many uses. It is perhaps most familiar as the gas that gives the “fizz” in soda pop and other carbonated beverages. In industrial applications, it is used for its chemical properties, its mechanical properties as a pressurizing agent, or its refrigerating properties as dry ice.

For fire-extinguishing applications, carbon dioxide has a number of desirable properties. It is noncorrosive, nondamaging, and leaves no residue to clean up after the fire. It provides its own pressure for discharge through pipes and nozzles. Because it is a gas, it will penetrate and spread to all parts of a hazard. It will not conduct electricity and can therefore be used on live electrical hazards. It can effectively be used on practically all combustible materials except for a few active metals and metal hydrides and materials, such as cellulose nitrate, that contain available oxygen.

Under normal conditions, carbon dioxide is an odorless, colorless gas with a density about 50 percent greater than the density of air. Many people insist they can detect an odor of carbon dioxide, but this could be due to impurities or chemical effects in the nostrils. Carbon dioxide is easily liquefied by compression and cooling. By further cooling and expansion, it can be converted to the solid state.

The relationship between the temperature and the pressure of liquid carbon dioxide is shown on the curve given in Figure G.1. As the temperature of the liquid increases, the pressure also increases. As the pressure increases, the density of the vapor over the liquid increases. On the other hand, the liquid expands as the temperature goes up and its density decreases. At 87.8°F (31°C), the liquid and the vapor have the same density, and of course the liquid phase disappears. This is called the critical temperature for carbon dioxide. Below the critical temperature [87.8°F (31°C)], carbon dioxide in a closed container is part liquid and part gas. Above the critical temperature, it is entirely gas.

An unusual property of carbon dioxide is the fact that it cannot exist as a liquid at pressures below 60.4 psi [75 psi absolute (517 kPa)]. This is the triple point pressure where carbon dioxide could be present as a solid, a liquid, or a vapor. Below this pressure, it must be either a solid or a gas, depending on the temperature.

If the pressure in a storage container is reduced by bleeding off vapor, some of the liquid will vaporize and the remaining liquid will become colder. At 60.4 psi [75 psi absolute (517 kPa)], the remaining liquid will be converted to dry ice at a temperature of -69.9°F (-57°C). Further reduction in the pressure to atmospheric will lower the temperature of the dry ice to the normal -109.3°F (-79°C).

The same process takes place when liquid carbon dioxide is discharged to the atmosphere. A large portion of the liquid flashes to vapor with a considerable increase in volume. The rest is converted to finely divided particles of dry ice at -109.3°F (-79°C). It is this dry ice or snow that gives the discharge its typical white cloudy appearance. The low temperature also causes the condensation of water from the entrained air so that ordinary water fog tends to persist for a while after the dry ice has sublimed.

Carbon dioxide is a colorless, odorless, electrically nonconductive inert gas that is a suitable medium for extinguishing fires. Liquid carbon dioxide forms solid dry ice (“snow”) when released directly into the atmosphere. Carbon dioxide gas is 1.5 times heavier than air. Carbon dioxide extinguishes fire by reducing the concentrations of oxygen, the vapor phase of the fuel, or both in the air to the point where combustion stops. (See Section 4.3.)

Carbon dioxide fire-extinguishing systems are useful within the limits of this standard in extinguishing fires involving specific hazards or equipment in the following occupancies:

- (1) Where an inert electrically nonconductive medium is essential or desirable
- (2) Where cleanup of other media presents a problem
- (3) Where such systems are more economical to install than systems using other media

Some of the types of hazards and equipment that carbon dioxide systems can satisfactorily protect include the following:

- (1) Flammable liquid materials (See 4.5.4.9.)
- (2) Electrical hazards such as transformers, switches, circuit breakers, rotating equipment, and electronic equipment
- (3) Engines utilizing gasoline and other flammable liquid fuels
- (4) Ordinary combustibles such as paper, wood, and textiles
- (5) Hazardous solids

**Table G.1 Acute Health Effects of High Concentrations of Carbon Dioxide (with Increasing Exposure Levels of Carbon Dioxide)**

Concentration of Carbon Dioxide in Air (%)	Time	Effects
2	Several hours	Headache, dyspnea upon mild exertion
3	1 hour	Dilation of cerebral blood vessels, increased pulmonary ventilation, and increased oxygen delivery to the tissues
4–5	Within a few minutes	Mild headache, sweating, and dyspnea at rest
6	1–2 minutes	Hearing and visible disturbances
	<16 minutes Several hours	Headache and dyspnea Tremors
7–10	Few minutes	Unconsciousness or near unconsciousness
	1.5 minutes–1 hour	Headache, increased heart rate, shortness of breath, dizziness, sweating, rapid breathing
10–15	1+ minute	Dizziness, drowsiness, severe muscle twitching, and unconsciousness
17–30	<1 minute	Loss of controlled and purposeful activity, unconsciousness, convulsions, coma, and death

Source: EPA 430-R-00-002, February 2000.

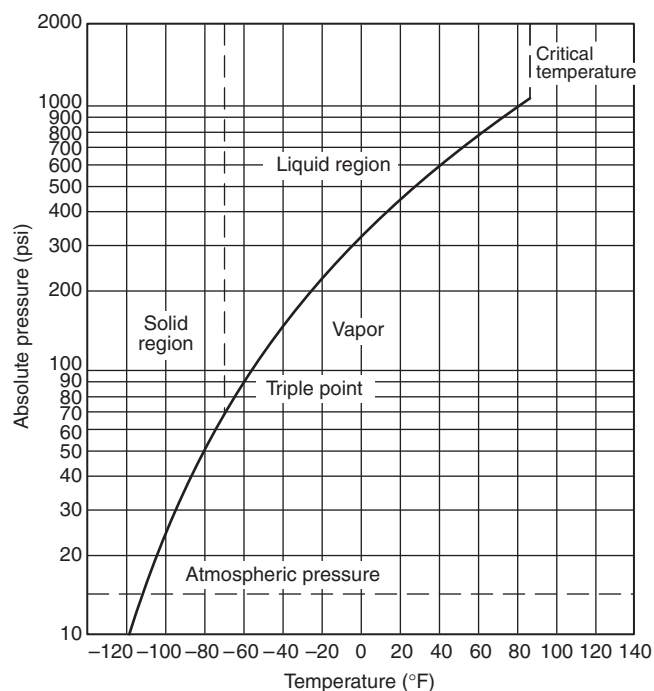

For SI units, 1 psi = 6.89 kPa; °C =  $\frac{5}{9}(\text{°F} - 32)$ .

**FIGURE G.1 Variation of Pressure of Carbon Dioxide with Change in Temperature (constant volume).**

## Annex H Informational References

**Δ H.1 Referenced Publications.** The documents or portions thereof listed in this annex are referenced within the informational sections of this standard and are not part of the requirements of this document unless also listed in Chapter 2 for other reasons.

**H.1.1 NFPA Publications.** National Fire Protection Association, 1 Batterymarch Park, Quincy, MA 02169-7471.

NFPA 10, *Standard for Portable Fire Extinguishers*, 2018 edition.

NFPA 69, *Standard on Explosion Prevention Systems*, 2014 edition.

NFPA 72®, *National Fire Alarm and Signaling Code*®, 2016 edition.

NFPA 77, *Recommended Practice on Static Electricity*, 2014 edition.

NFPA 96, *Standard for Ventilation Control and Fire Protection of Commercial Cooking Operations*, 2017 edition.

NFPA 101®, *Life Safety Code*®, 2018 edition.

### H.1.2 Other Publications.

**H.1.2.1 ASME Publications.** American Society of Mechanical Engineers, Two Park Avenue, New York, NY 10016-5990.

ASME B31.1, *Power Piping Code*, 2016.

**H.1.2.2 ASTM Publications.** ASTM International, 100 Barr Harbor Drive, P.O. Box C700, West Conshohocken, PA 19428-2959.

ASTM SI10, *American National Standard for Metric Practice*, 2016.

**H.1.2.3 DHHS Publications.** Department of Health and Human Services, National Institute of Safety and Health, Robert A. Taft Laboratory, 4676 Columbia Parkway, Cincinnati, OH 45226.

DHHS (NIOSH) Publication 76-194, *Criteria for a Recommended Standard: Occupational Exposure to Carbon Dioxide*, 1976.

**H.1.2.4 EPA Publications.** Environmental Protection Agency, William Jefferson Clinton East Bldg., 1200 Pennsylvania Avenue, NW, Washington, DC 20460.

EPA 430-R-00-002, “Carbon Dioxide as a Fire Suppressant: Examining the Risks,” February 2000.

**Δ H.1.2.5 FM Global Publications.** FM Global, 1175 Boston-Providence Turnpike, P.O. Box 9102, Norwood, MA 02062.

FM Approvals 5420, *Approval Standard for Carbon Dioxide Extinguishing Systems*, April 2007.

**Δ H.1.2.6 FSSA Publications.** Fire Suppression Systems Association, 3601 E. Joppa Road, Baltimore, MD 21234. (www.fssa.net)

*FSSA Application Guide Detection & Control for Fire Suppression Systems*, November 2010.

*FSSA Design Guide for Use with Carbon Dioxide Total Flooding Applications*, 1st edition, February 2011.

*FSSA Design Guidelines for Carbon Dioxide Local Application Rate-by-Area*, January 2010.

*FSSA Design Guidelines for Carbon Dioxide Local Application Rate-by-Volume*, December 2005.

*FSSA Fire Protection Systems Inspection Form Guidelines*, January 2012.

*FSSA Pipe Design Handbook for Use with Special Hazard Fire Suppression Systems*, 2nd edition, 2011.

*FSSA Test Guide for Use with Special Hazard Fire Suppression Systems Containers*, 3rd edition, January 2012.

**N H.1.2.7 MSS Publications.** Manufacturers Standardization Society (MSS) of the Valve and Fittings Industry, 127 Park St. NE, Vienna VA 22180-4602.

ANSI/MSS SP-58, *Pipe Hangers and Supports — Materials, Design, Manufacture, Selection, Application, and Installation*, 2009.

MSS SP-127, *Bracing for Piping Systems: Seismic-Wind-Dynamic Design, Selection, and Application*, 2014a.

**N H.1.2.8 SFPE Publications.** Society of Fire Protection Engineers, 9711 Washingtonian Blvd, Suite 380, Gaithersburg, MD 20878.

*SFPE Handbook of Fire Protection Engineering*, 5th edition.

**H.1.2.9 U.S. Government Publications.** U.S. Government Publishing Office, 732 North Capitol Street, NW, Washington, DC 20401-0001.

Title 46, Code of Federal Regulations, Part 119, “Machinery Installations.”

Title 49, Code of Federal Regulations, Parts 171–190 (Department of Transportation).

## H.2 Informational References.

**N H.2.1 FSSA Publications.** Fire Suppression Systems Association, 3601 E. Joppa Road, Baltimore, MD 21234. (www.fssa.net)

*FSSA General Information Guide for Carbon Dioxide Fire Extinguishing Systems*, January 2014.

**H.3 References for Extracts in Informational Sections. (Reserved)**

## Index

Copyright © 2017 National Fire Protection Association. All Rights Reserved.

The copyright in this index is separate and distinct from the copyright in the document that it indexes. The licensing provisions set forth for the document are not applicable to this index. This index may not be reproduced in whole or in part by any means without the express written permission of NFPA.

- A-**
- Administration**, Chap. 1
  - Purpose, 1.2
  - Equivalency, 1.2.2
  - Retroactivity, 1.3
  - Scope, 1.1, A.1.1
  - Units, 1.4, A.1.4
- Alarms and Indicators**
  - Definition, 3.3.1
- Approved**
  - Definition, 3.2.1, A.3.2.1
- Authority Having Jurisdiction (AHJ)**
  - Definition, 3.2.2, A.3.2.2
- D-**
- Definitions**, Chap. 3
- E-**
- Examples of Hazard Protection**, Annex B
  - Below Raised Floors, B.6
  - Commercial/Industrial Food Processing Deep-Fat (Hot Oil) Cookers, B.2
    - Summary of Protection, B.2.1
      - Drain Board, B.2.1.3
      - Equipment Shutdown, B.2.1.7
      - External Oil Heater, B.2.1.5
      - Fume-Exhaust and Fume-Removal System, B.2.1.4
      - Hydraulic Oil System, B.2.1.6
      - Permanent Enclosure, B.2.1.2
        - Vat, B.2.1.1
    - Introduction, B.1
    - Newspaper Printing and Rotogravure Presses, B.4
    - Open-Top Pits, B.5
    - Restaurant Range Hoods, Connected Ducts, and Associated Hazards, B.3
- Explanatory Material**, Annex A
- F-**
- Fire Watch**
  - Definition, 3.3.2
- G-**
- General Information**, Chap. 4
  - Carbon Dioxide Supply, 4.6
    - High-Pressure Cylinders, 4.6.5, A.4.6.5
      - Manifolded Cylinders, 4.6.5.4
      - Pressure Relief Device, 4.6.5.3
    - Low-Pressure Storage Containers, 4.6.6, A.4.6.6
      - Container Requirements, 4.6.6.1
      - Heating, 4.6.6.5
      - Quality, 4.6.3, A.4.6.3
      - Quantities, 4.6.1, A.4.6.1
      - Replenishment, 4.6.2
      - Storage Containers, 4.6.4
  - Carbon Dioxide Use and Limitations, 4.2
  - Detection, Actuation, and Control, 4.5
    - Alarms, 4.5.6, A.4.5.6
      - PredischARGE Alarm and Time Delay, 4.5.6.2
    - Automatic Detection, 4.5.3, A.4.5.3
    - Automatic Detection and Automatic Actuation, 4.5.2, A.4.5.2
    - Classification, 4.5.1
      - Automatic Operation, 4.5.1.1
      - Emergency Manual Operation, 4.5.1.3, A.4.5.1.3
      - Normal Manual Operation, 4.5.1.2
    - Operating Devices, 4.5.4
      - Cylinders, 4.5.4.7, A.4.5.4.7
      - Device Design, 4.5.4.2
      - Discharge Pressure Switch, 4.5.4.13
      - Listed and Approved, 4.5.4.1
      - Manual Controls, 4.5.4.8
    - Power Sources, 4.5.7
    - Supervision and Lockout Valves, 4.5.5
  - Distribution Systems, 4.7, A.4.7
    - Discharge Nozzles, 4.7.4, A.4.7.4
      - Discharge Devices, 4.7.4.5
    - Pipe and Orifice Size Determination, 4.7.5
    - Pipe Hangers and Supports, 4.7.6, A.4.7.6
    - Valves, 4.7.3
  - Inspection, Maintenance, and Instruction, 4.8, A.4.8
    - Hose Testing, 4.8.2
    - Inspection, 4.8.1, A.4.8.1
    - Instruction, 4.8.4, A.4.8.4
    - Maintenance, 4.8.3, A.4.8.3
      - High-Pressure Cylinder Weights, 4.8.3.5
      - Low-Pressure Container Liquid Levels, 4.8.3.6
      - Test and Maintenance Procedures, 4.8.3.1
  - Personnel Safety, 4.3, A.4.3
    - Duration of Protection, 4.3.5, A.4.3.5
    - Electrical Clearances, 4.3.4
    - Evacuation Procedures, 4.3.3
    - Hazards to Personnel, 4.3.1, A.4.3.1
    - Signs, 4.3.2
  - Restrictions for Normally Occupied Enclosures, 4.1
    - Existing Systems, 4.1.2
  - Specifications, Plans, and Approvals, 4.4
    - Approval of Installations, 4.4.3, A.4.4.3
    - Plans, 4.4.2
    - Specifications, 4.4.1
    - Testing of Systems, 4.4.4
      - Handheld Hose Lines, 4.4.4.3



Local Application, 4.4.4.1

Total Flooding, 4.4.4.2

**General Information on Carbon Dioxide, Annex G**

**-H-**

**Hand Hose Line Systems, Chap. 7**

Carbon Dioxide Requirements, 7.4

Provision for Use by Inexperienced Personnel, 7.4.2

Rate and Duration of Discharge, 7.4.1

Simultaneous Use, 7.4.3

Equipment Specifications, 7.5

Charging the Hose Line, 7.5.4, A.7.5.4

Discharge Nozzle Assembly, 7.5.2, A.7.5.2

Hose, 7.5.1

Hose Line Storage, 7.5.3

General Information, 7.1

Description, 7.1.1, A.7.1.1

General Requirements, 7.1.3

Safety Requirements, 7.1.4, A.7.1.4

Uses, 7.1.2

Hazard Specifications, 7.2

Location and Spacing, 7.3

Location, 7.3.1

Spacing, 7.3.2

Training, 7.6

**-I-**

**Informational References, Annex H**

**Inspection**

Definition, 3.3.3

**-L-**

**Labeled**

Definition, 3.2.3

**Listed**

Definition, 3.2.4, A.3.2.4

**Local Application Carbon Dioxide Systems, Annex F**

**Local Application Systems, Chap. 6**

Carbon Dioxide Requirements, 6.3

Duration of Discharge, 6.3.3, A.6.3.3

General, 6.3.1, A.6.3.1

High-Pressure Storage, 6.3.1.1, A.6.3.1.1

Rate of Discharge, 6.3.2

Distribution System, 6.6

Discharge Nozzles, 6.6.3

General, 6.6.1

Piping Systems, 6.6.2, A.6.6.2

General Information, 6.1

Description, 6.1.1

General Requirements, 6.1.3

Safety Requirements, 6.1.4, A.6.1.4

Uses, 6.1.2, A.6.1.2

Hazard Specifications, 6.2

Extent of Hazard, 6.2.1

Location of Hazard, 6.2.2

Rate-by-Area Method, 6.4

Area per Nozzle, 6.4.3

General, 6.4.1, A.6.4.1

Location and Number of Nozzles, 6.4.4

Nozzles Installed at an Angle, 6.4.4.3

Nozzle Discharge Rates, 6.4.2

Rate-by-Volume Method, 6.5

Assumed Enclosure, 6.5.2

General, 6.5.1, A.6.5.1

Location and Number of Nozzles, 6.5.4

System Discharge Rate, 6.5.3

**Lockout**

Definition, 3.3.4

**-M-**

**Maintenance**

Definition, 3.3.5

**Marine System Spaces**

Cargo Space

Definition, 3.4.2.1

Definition, 3.4.2

Electrical Equipment Space

Definition, 3.4.2.2

Machinery Space

Definition, 3.4.2.3

Vehicle Space

Definition, 3.4.2.4

**Marine Systems**

Definition, 3.4.1

**Marine Systems, Chap. 9**

General, 9.2

Outline, 9.2.1, A.9.2.1

Inspection and Maintenance, 9.4

Approval of Installations, 9.4.2

High-Pressure Systems, 9.4.2.2

Systems with Stop Valves, 9.4.2.2.1

Systems Without Stop Valves, 9.4.2.2.2

Low-Pressure Systems, 9.4.2.3

Normally Pressurized Piping, 9.4.2.3.1

Piping Between the Tank Shutoff Valve and  
Nozzles, 9.4.2.3.2

General, 9.4.1

PredischARGE Delays, Alarms, and Shutdowns, 9.4.3

Verification, 9.4.4

Special Definitions, 9.1

System Requirements, 9.3

Actuation, 9.3.3

Controls, 9.3.3.4, A.9.3.3.4

Release Box, 9.3.3.6

Source of Power, 9.3.3.7, A.9.3.3.7

Carbon Dioxide Storage, 9.3.4

Components, 9.3.1

Electrical Equipment Spaces, 9.3.7

Operating Instructions, 9.3.2

System Design, 9.3.6

Cargo Spaces, 9.3.6.2

Machinery Spaces, 9.3.6.1

Vehicle Spaces, 9.3.6.4

Vehicle Spaces, 9.3.6.3

- System Piping, 9.3.5
- N-
- Normally Occupied Enclosure or Space**  
Definition, 3.3.6
- Normally Unoccupied Enclosure or Space**  
Definition, 3.3.7, A.3.3.7
- O-
- Occupiable Enclosure or Space**  
Definition, 3.3.8
- P-
- Pipe and Orifice Size Determination**, Annex C
- Pressure**  
Definition, 3.3.9  
High Pressure  
Definition, 3.3.9.1, A.3.3.9.1  
Low Pressure  
Definition, 3.3.9.2, A.3.3.9.2
- R-
- Referenced Publications**, Chap. 2
- S-
- Shall**  
Definition, 3.2.5
- Should**  
Definition, 3.2.6
- Standard**  
Definition, 3.2.7
- Standpipe System and Mobile Supply**  
Definition, 3.3.10
- Standpipe Systems and Mobile Supply**, Chap. 8  
General Information, 8.1  
Description, 8.1.1, A.8.1.1  
General Requirements, 8.1.3  
Uses, 8.1.2, A.8.1.2  
Hazard Specifications, 8.2  
Mobile Supply Requirements, 8.4  
Accessories, 8.4.5  
Capacity, 8.4.1, A.8.4.1  
Coupling, 8.4.2  
Location, 8.4.4  
Mobility, 8.4.3  
Standpipe Requirements, 8.3  
Training, 8.5, A.8.5
- Surface Fires**, Annex E
- System**  
Definition, 3.3.11  
Hand Hose Line System  
Definition, 3.3.11.1
- Local Application System  
Definition, 3.3.11.2
- Pre-Engineered System  
Definition, 3.3.11.3, A.3.3.11.3
- Total Flooding System  
Definition, 3.3.11.4
- T-
- Total Flooding Systems**, Annex D  
Additional Resources, D.2  
Design Theory, D.1
- Total Flooding Systems**, Chap. 5  
Carbon Dioxide Requirements for Deep-Seated Fires, 5.4  
Combustible Materials, 5.4.2, A.5.4.2  
Other Deep-Seated Fires, 5.4.2.2  
General, 5.4.1, A.5.4.1  
Special Conditions, 5.4.4  
Volume Consideration, 5.4.3  
Carbon Dioxide Requirements for Surface Fires, 5.3  
Flammable Materials, 5.3.2  
General, 5.3.1  
Material Conversion Factor, 5.3.4  
Special Conditions, 5.3.5  
Flooding Factor, 5.3.5.7, A.5.3.5.7  
Openings That Cannot Be Closed, 5.3.5.1, A.5.3.5.1  
Ventilating Systems, 5.3.5.2  
Volume Factor, 5.3.3  
Interconnected Volumes, 5.3.3.2  
Distribution System, 5.5  
Enclosed Rotating Electrical Equipment, 5.5.3, A.5.5.3  
General, 5.5.1  
Nozzle Sizing and Distribution, 5.5.5  
Nozzle Selection, 5.5.5.1  
Piping Systems, 5.5.4  
Rate of Application, 5.5.2, A.5.5.2  
General Information, 5.1  
Description, 5.1.1  
General Requirements, 5.1.3  
Safety Requirements, 5.1.4  
Uses, 5.1.2, A.5.1.2  
Hazard Specifications, 5.2  
Enclosure, 5.2.1, A.5.2.1  
Leakage and Ventilation, 5.2.2  
Types of Fires, 5.2.3, A.5.2.3  
Venting Consideration, 5.6  
General, 5.6.1, A.5.6.1  
Pressure Relief Venting, 5.6.2, A.5.6.2
- U-
- Unoccupiable Enclosure or Space**  
Definition, 3.3.12

## Sequence of Events for the Standards Development Process

Once the current edition is published, a Standard is opened for Public Input.

### Step 1 – Input Stage

- Input accepted from the public or other committees for consideration to develop the First Draft
- Technical Committee holds First Draft Meeting to revise Standard (23 weeks); Technical Committee(s) with Correlating Committee (10 weeks)
- Technical Committee ballots on First Draft (12 weeks); Technical Committee(s) with Correlating Committee (11 weeks)
- Correlating Committee First Draft Meeting (9 weeks)
- Correlating Committee ballots on First Draft (5 weeks)
- First Draft Report posted on the document information page

### Step 2 – Comment Stage

- Public Comments accepted on First Draft (10 weeks) following posting of First Draft Report
- If Standard does not receive Public Comments and the Technical Committee chooses not to hold a Second Draft meeting, the Standard becomes a Consent Standard and is sent directly to the Standards Council for issuance (see Step 4) or
- Technical Committee holds Second Draft Meeting (21 weeks); Technical Committee(s) with Correlating Committee (7 weeks)
- Technical Committee ballots on Second Draft (11 weeks); Technical Committee(s) with Correlating Committee (10 weeks)
- Correlating Committee Second Draft Meeting (9 weeks)
- Correlating Committee ballots on Second Draft (8 weeks)
- Second Draft Report posted on the document information page

### Step 3 – NFPA Technical Meeting

- Notice of Intent to Make a Motion (NITMAM) accepted (5 weeks) following the posting of Second Draft Report
- NITMAMs are reviewed and valid motions are certified by the Motions Committee for presentation at the NFPA Technical Meeting
- NFPA membership meets each June at the NFPA Technical Meeting to act on Standards with “Certified Amending Motions” (certified NITMAMs)
- Committee(s) vote on any successful amendments to the Technical Committee Reports made by the NFPA membership at the NFPA Technical Meeting

### Step 4 – Council Appeals and Issuance of Standard

- Notification of intent to file an appeal to the Standards Council on Technical Meeting action must be filed within 20 days of the NFPA Technical Meeting
- Standards Council decides, based on all evidence, whether to issue the standard or to take other action

#### Notes:

1. Time periods are approximate; refer to published schedules for actual dates.
2. Annual revision cycle documents with certified amending motions take approximately 101 weeks to complete.
3. Fall revision cycle documents receiving certified amending motions take approximately 141 weeks to complete.

## Committee Membership Classifications<sup>1,2,3,4</sup>

The following classifications apply to Committee members and represent their principal interest in the activity of the Committee.

1. M *Manufacturer*: A representative of a maker or marketer of a product, assembly, or system, or portion thereof, that is affected by the standard.
2. U *User*: A representative of an entity that is subject to the provisions of the standard or that voluntarily uses the standard.
3. IM *Installer/Maintainer*: A representative of an entity that is in the business of installing or maintaining a product, assembly, or system affected by the standard.
4. L *Labor*: A labor representative or employee concerned with safety in the workplace.
5. RT *Applied Research/Testing Laboratory*: A representative of an independent testing laboratory or independent applied research organization that promulgates and/or enforces standards.
6. E *Enforcing Authority*: A representative of an agency or an organization that promulgates and/or enforces standards.
7. I *Insurance*: A representative of an insurance company, broker, agent, bureau, or inspection agency.
8. C *Consumer*: A person who is or represents the ultimate purchaser of a product, system, or service affected by the standard, but who is not included in (2).
9. SE *Special Expert*: A person not representing (1) through (8) and who has special expertise in the scope of the standard or portion thereof.

NOTE 1: “Standard” connotes code, standard, recommended practice, or guide.

NOTE 2: A representative includes an employee.

NOTE 3: While these classifications will be used by the Standards Council to achieve a balance for Technical Committees, the Standards Council may determine that new classifications of member or unique interests need representation in order to foster the best possible Committee deliberations on any project. In this connection, the Standards Council may make such appointments as it deems appropriate in the public interest, such as the classification of “Utilities” in the National Electrical Code Committee.

NOTE 4: Representatives of subsidiaries of any group are generally considered to have the same classification as the parent organization.

## Submitting Public Input / Public Comment Through the Online Submission System

Soon after the current edition is published, a Standard is open for Public Input.

Before accessing the Online Submission System, you must first sign in at [www.nfpa.org](http://www.nfpa.org). *Note: You will be asked to sign-in or create a free online account with NFPA before using this system:*

- a. Click on Sign In at the upper right side of the page.
- b. Under the Codes and Standards heading, click on the “List of NFPA Codes & Standards,” and then select your document from the list or use one of the search features.

*OR*

- a. Go directly to your specific document information page by typing the convenient shortcut link of [www.nfpa.org/document#](http://www.nfpa.org/document#) (Example: NFPA 921 would be [www.nfpa.org/921](http://www.nfpa.org/921)). Sign in at the upper right side of the page.

To begin your Public Input, select the link “The next edition of this standard is now open for Public Input” located on the About tab, Current & Prior Editions tab, and the Next Edition tab. Alternatively, the Next Edition tab includes a link to Submit Public Input online.

At this point, the NFPA Standards Development Site will open showing details for the document you have selected. This “Document Home” page site includes an explanatory introduction, information on the current document phase and closing date, a left-hand navigation panel that includes useful links, a document Table of Contents, and icons at the top you can click for Help when using the site. The Help icons and navigation panel will be visible except when you are actually in the process of creating a Public Input.

Once the First Draft Report becomes available there is a Public Comment period during which anyone may submit a Public Comment on the First Draft. Any objections or further related changes to the content of the First Draft must be submitted at the Comment stage.

To submit a Public Comment you may access the online submission system utilizing the same steps as previously explained for the submission of Public Input.

For further information on submitting public input and public comments, go to: <http://www.nfpa.org/publicinput>.

### Other Resources Available on the Document Information Pages

**About tab:** View general document and subject-related information.

**Current & Prior Editions tab:** Research current and previous edition information on a Standard.

**Next Edition tab:** Follow the committee’s progress in the processing of a Standard in its next revision cycle.

**Technical Committee tab:** View current committee member rosters or apply to a committee.

**Technical Questions tab:** For members and Public Sector Officials/AHJs to submit questions about codes and standards to NFPA staff. Our Technical Questions Service provides a convenient way to receive timely and consistent technical assistance when you need to know more about NFPA codes and standards relevant to your work. Responses are provided by NFPA staff on an informal basis.

**Products & Training tab:** List of NFPA’s publications and training available for purchase.

## Information on the NFPA Standards Development Process

**I. Applicable Regulations.** The primary rules governing the processing of NFPA standards (codes, standards, recommended practices, and guides) are the NFPA *Regulations Governing the Development of NFPA Standards (Regs)*. Other applicable rules include NFPA *Bylaws*, NFPA *Technical Meeting Convention Rules*, NFPA *Guide for the Conduct of Participants in the NFPA Standards Development Process*, and the NFPA *Regulations Governing Petitions to the Board of Directors from Decisions of the Standards Council*. Most of these rules and regulations are contained in the *NFPA Standards Directory*. For copies of the *Directory*, contact Codes and Standards Administration at NFPA Headquarters; all these documents are also available on the NFPA website at “www.nfpa.org.”

The following is general information on the NFPA process. All participants, however, should refer to the actual rules and regulations for a full understanding of this process and for the criteria that govern participation.

**II. Technical Committee Report.** The Technical Committee Report is defined as “the Report of the responsible Committee(s), in accordance with the Regulations, in preparation of a new or revised NFPA Standard.” The Technical Committee Report is in two parts and consists of the First Draft Report and the Second Draft Report. (See *Regs* at Section 1.4.)

**III. Step 1: First Draft Report.** The First Draft Report is defined as “Part one of the Technical Committee Report, which documents the Input Stage.” The First Draft Report consists of the First Draft, Public Input, Committee Input, Committee and Correlating Committee Statements, Correlating Notes, and Ballot Statements. (See *Regs* at 4.2.5.2 and Section 4.3.) Any objection to an action in the First Draft Report must be raised through the filing of an appropriate Comment for consideration in the Second Draft Report or the objection will be considered resolved. [See *Regs* at 4.3.1(b).]

**IV. Step 2: Second Draft Report.** The Second Draft Report is defined as “Part two of the Technical Committee Report, which documents the Comment Stage.” The Second Draft Report consists of the Second Draft, Public Comments with corresponding Committee Actions and Committee Statements, Correlating Notes and their respective Committee Statements, Committee Comments, Correlating Revisions, and Ballot Statements. (See *Regs* at 4.2.5.2 and Section 4.4.) The First Draft Report and the Second Draft Report together constitute the Technical Committee Report. Any outstanding objection following the Second Draft Report must be raised through an appropriate Amending Motion at the NFPA Technical Meeting or the objection will be considered resolved. [See *Regs* at 4.4.1(b).]

**V. Step 3a: Action at NFPA Technical Meeting.** Following the publication of the Second Draft Report, there is a period during which those wishing to make proper Amending Motions on the Technical Committee Reports must signal their intention by submitting a Notice of Intent to Make a Motion (NITMAM). (See *Regs* at 4.5.2.) Standards that receive notice of proper Amending Motions (Certified Amending Motions) will be presented for action at the annual June NFPA Technical Meeting. At the meeting, the NFPA membership can consider and act on these Certified Amending Motions as well as Follow-up Amending Motions, that is, motions that become necessary as a result of a previous successful Amending Motion. (See 4.5.3.2 through 4.5.3.6 and Table 1, Columns 1-3 of *Regs* for a summary of the available Amending Motions and who may make them.) Any outstanding objection following action at an NFPA Technical Meeting (and any further Technical Committee consideration following successful Amending Motions, see *Regs* at 4.5.3.7 through 4.6.5.3) must be raised through an appeal to the Standards Council or it will be considered to be resolved.

**VI. Step 3b: Documents Forwarded Directly to the Council.** Where no NITMAM is received and certified in accordance with the Technical Meeting Convention Rules, the standard is forwarded directly to the Standards Council for action on issuance. Objections are deemed to be resolved for these documents. (See *Regs* at 4.5.2.5.)

**VII. Step 4a: Council Appeals.** Anyone can appeal to the Standards Council concerning procedural or substantive matters related to the development, content, or issuance of any document of the NFPA or on matters within the purview of the authority of the Council, as established by the Bylaws and as determined by the Board of Directors. Such appeals must be in written form and filed with the Secretary of the Standards Council (see *Regs* at Section 1.6). Time constraints for filing an appeal must be in accordance with 1.6.2 of the *Regs*. Objections are deemed to be resolved if not pursued at this level.

**VIII. Step 4b: Document Issuance.** The Standards Council is the issuer of all documents (see Article 8 of *Bylaws*). The Council acts on the issuance of a document presented for action at an NFPA Technical Meeting within 75 days from the date of the recommendation from the NFPA Technical Meeting, unless this period is extended by the Council (see *Regs* at 4.7.2). For documents forwarded directly to the Standards Council, the Council acts on the issuance of the document at its next scheduled meeting, or at such other meeting as the Council may determine (see *Regs* at 4.5.2.5 and 4.7.4).

**IX. Petitions to the Board of Directors.** The Standards Council has been delegated the responsibility for the administration of the codes and standards development process and the issuance of documents. However, where extraordinary circumstances requiring the intervention of the Board of Directors exist, the Board of Directors may take any action necessary to fulfill its obligations to preserve the integrity of the codes and standards development process and to protect the interests of the NFPA. The rules for petitioning the Board of Directors can be found in the *Regulations Governing Petitions to the Board of Directors from Decisions of the Standards Council* and in Section 1.7 of the *Regs*.

**X. For More Information.** The program for the NFPA Technical Meeting (as well as the NFPA website as information becomes available) should be consulted for the date on which each report scheduled for consideration at the meeting will be presented. To view the First Draft Report and Second Draft Report as well as information on NFPA rules and for up-to-date information on schedules and deadlines for processing NFPA documents, check the NFPA website (www.nfpa.org/docinfo) or contact NFPA Codes & Standards Administration at (617) 984-7246.





# Xchange<sup>TM</sup>

The place to connect online with your fire, electrical, and life safety peers

**Have a question about the code or standard you're reading now?**

**NFPA Xchange<sup>TM</sup> can help!**

NFPA Xchange<sup>TM</sup> brings together over 30,000 professionals worldwide, asking and answering each other's questions, sharing ideas, and discussing the issues impacting your industry today.

**NFPA Xchange<sup>TM</sup> is free to join and offers:**

- ➔ A robust collection of previously asked and answered questions to search
- ➔ Access to thousands of peers for problem-solving and on-the-job advice
- ➔ NFPA blogs, white papers, and webinars in one convenient place

NFPA members also enjoy Xchange<sup>TM</sup> Members Only, the online space for technical questions\* answered by NFPA staff, exclusive NFPA live events, and premier access to curated content.

**Join NFPA Xchange<sup>TM</sup> TODAY!**

**[www.nfpa.org/xchange](http://www.nfpa.org/xchange)**

***Xchange Today. Safer Tomorrow.***

\*For the full terms of use, please visit [nfpa.org/standard\\_items/terms-of-use#xchange](http://nfpa.org/standard_items/terms-of-use#xchange). NFPA® is a registered trademark of the National Fire Protection Association, Quincy, MA 02169.